

PPX-6030NFXB

GNSS Panel Mount Active antenna

The Joymax PPX-6030NFXB antenna is a dome-style, panel-mount, active antenna designed for use in 1575 MHz to 1610 MHz band supporting GNSS including GPS (L1), QZSS (L1), GLONASS (G1), and GALILEO (E1) for Navigation, Location, Timing applications.

The antenna provides high gain with built-in low noise amplifier (LNA) to enhance GNSS signal. The IP65 rated antennas terminate in a N-Type Jack (female socket) connector.



Features

- Bandwidth 1575.42 MHz to 1610 MHz
- Performance at 1575.42 MHz
 - VSWR: ≤ 2.0
 - Total Peak Gain: 28.8 dBi
 - Axial Ratio: 5.0 dB
- IP65 rated
- Right-hand circularly polarized (RHCP)
- Using screw mount to chassis or device enclosure

Applications

- Global Navigation Satellite System (GNSS)
 - GPS (L1) 1575.42 MHz
 - GLONASS (G1) 1602 MHz
 - GALILEO (E1) 1575.42 MHz
 - QZSS (L1) 1575.42 MHz
- Navigation, Timing, Location
- Smart Transportation
- Asset Tracking

Ordering Information

Part Number	Description
PPX-6030NFXB	GNSS panel-mount active dome antenna with N-Type Jack (female socket) connector

Available from Joymax Electronics and select distributors and representatives.

Table 1: Electrical Specifications

PPX-6030NFXB	GNSS L1 Band (MHz)		
Frequency Range	1561	1575.42	1602
VSWR (Max)	1.2	2.0	1.9
Total Peak Gain (dBi)	28.2	28.8	26.8
Axial Ratio (dB)	13.9	5.0	5.7
Noise Figure (dB)	1.2	1.3	1.3
Polarization	RHCP		
Radiation	Directional		
Input Voltage	Typ. 3.3 V		
Power Consumption	Typ. 8 ± 2 mA @ 3.3 V		
Wavelength	$\frac{1}{2}\lambda$		
Electrical Type	Radiating Patch plus 2-stage LNA		
Impedance	50 Ω		
ESD Sensitivity	Low ESD sensitivity. As a best practice, we may use ESD packaging.		

Electrical specifications and plots measured with the antenna on a 300mm x 300mm reference ground plane.

Table 2: Mechanical Specifications

Parameter	Value
Connection	N-Type Jack (female socket) or N-Type Plug (male pin) Connector
Operating Temp.	-30°C to +70°C
Weight	81 g
Dimension	30 mm x \varnothing 60 mm Radome
Antenna Color	Black
Ingress Protection	IP65
Storage Temp.	-40°C to +85°C

Ground Plane Independent Operation

The ground plane which is typically required for passive GNSS antenna in order to collect signal to increase gain performance, may not be required for active GNSS antennas because the significant signal gain is provided by antenna’s built-in LNA. LNA and filter diagram as shown below:

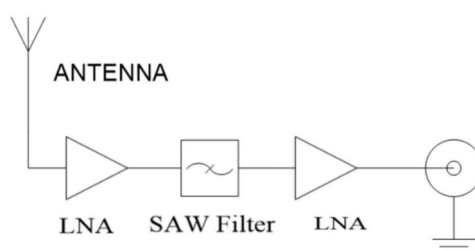

Product Dimensions

Figure 1 provides dimensions of the PPX-6030NFXB antenna and recommended mounting hole. The antenna is designed to be mount on end-user device enclosure panel or L bracket. The antenna should not be shielded by any metal plate on top.

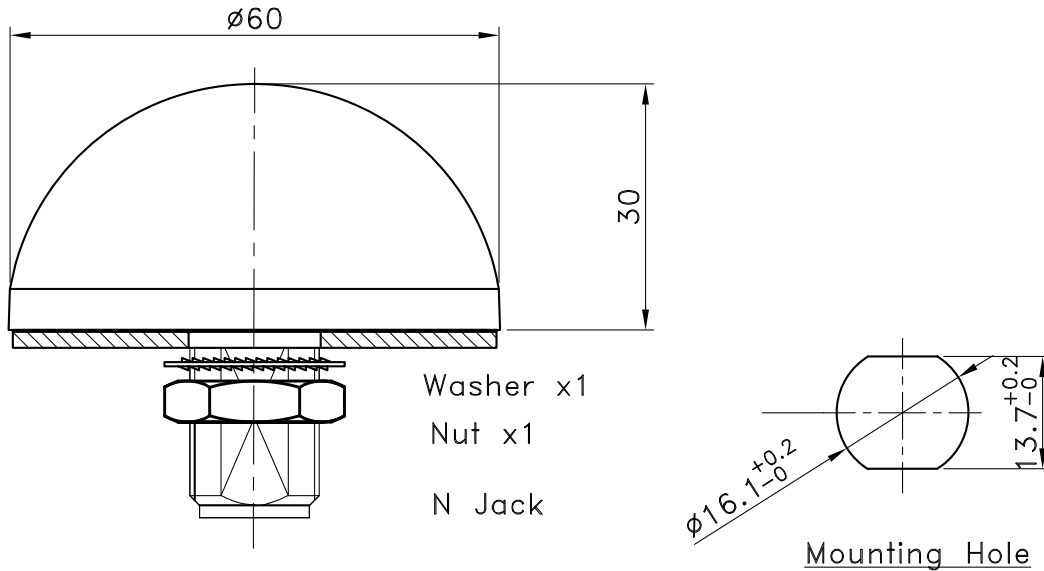
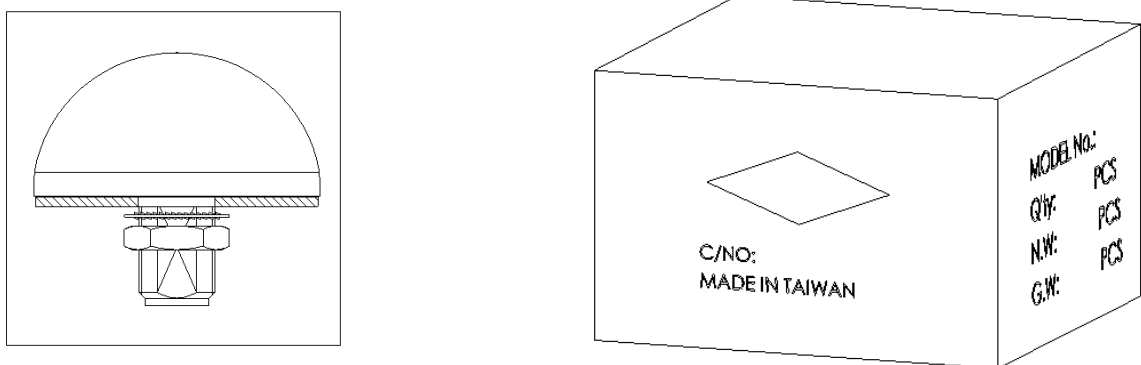

Figure 1. Antenna Dimensions

Packaging Information

The PPX-6030NFXB antennas are individually packaged into a small box as shown in Figure 2. 40 pcs per carton, 390 mm x 260 mm x 330 mm (15.4 in x 10.2 in x 13.0 in), total weight 5 kgs (11.0 lb). Distribution channels may offer alternative packaging options.



1 pcs antenna/ 1 Box

Figure 2. Antenna Packaging

Antenna Orientation

The PPX-6030NFXB antenna is designed to face sky to receive satellites signal. The antenna is characterized on a metal plate (300 mm x 300 mm) as shown in **Figure 3** providing insight into antenna performance when attached to a metal surfaces. The charts on the following pages represent data taken with the antenna oriented at the center of the metal plate.

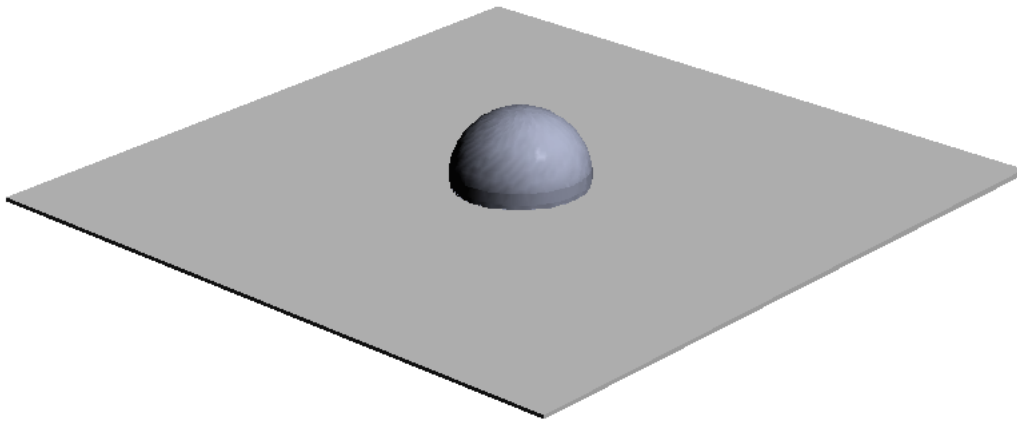

Figure 3. Antenna Test Orientation

VSWR

Figure 4 provides the voltage standing wave ratio (VSWR) across the antenna bandwidth. VSWR is a function of the reflection coefficient, which describes the power reflected from the antenna back to the radio. A lower VSWR value indicates better antenna performance at a given frequency. Reflected power is also shown on the right-side vertical axis as a gauge of the percentage of transmitter power reflected back from the antenna.

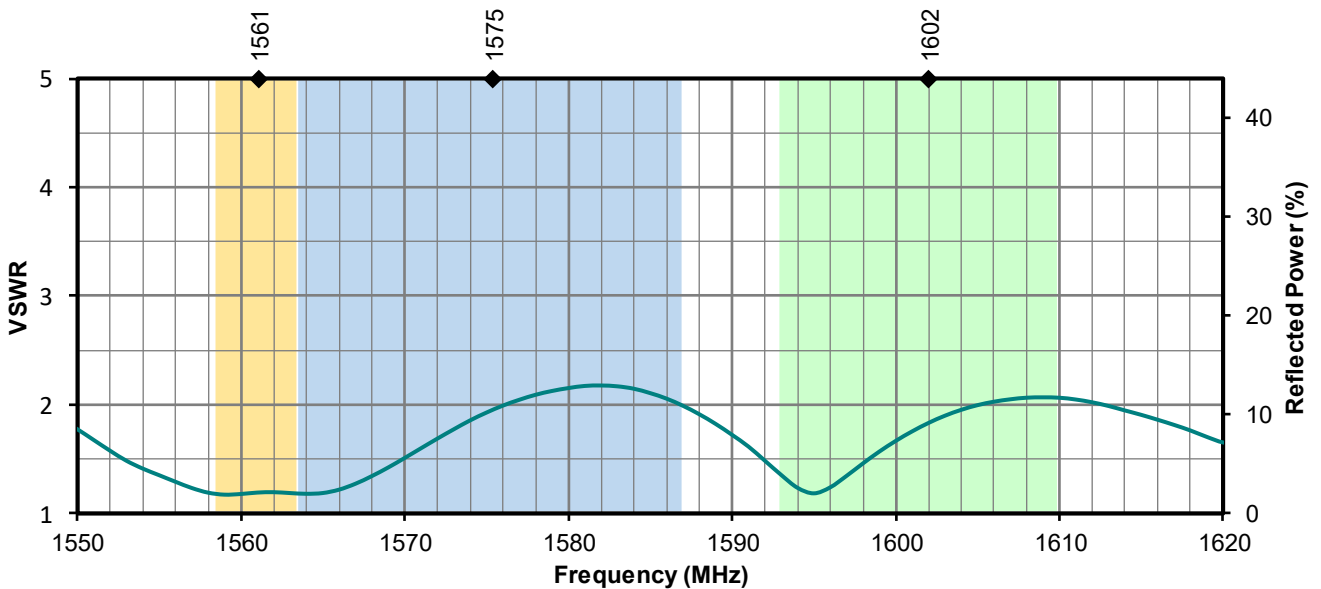

Figure 4. Antenna VSWR, with ground plane

Return Loss

Return loss (**Figure 5**), represents the loss in power at the antenna due to reflected signals. Like VSWR, a lower return loss value indicates better antenna performance at a given frequency.

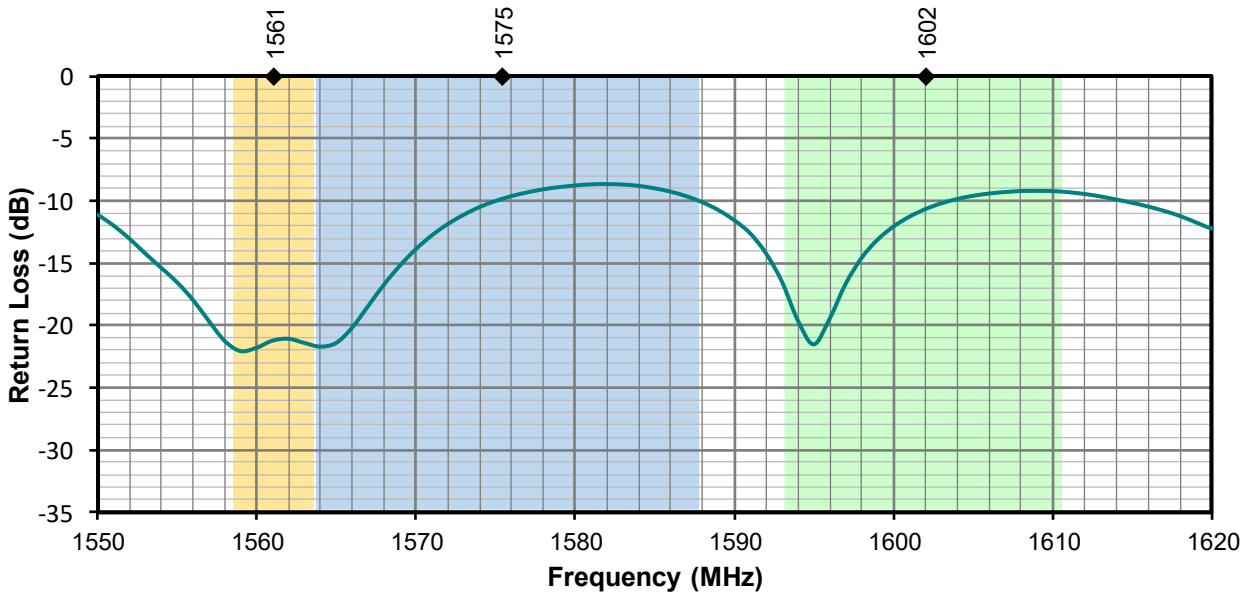

Figure 5. Antenna Return Loss, with ground plane

Total Peak Gain

The peak gain across the antenna bandwidth is shown in **Figure 6**. Peak gain represents the maximum antenna input power concentration across 3-dimensional space, and therefore peak performance at a given frequency, but does not consider any directionality in the gain pattern.

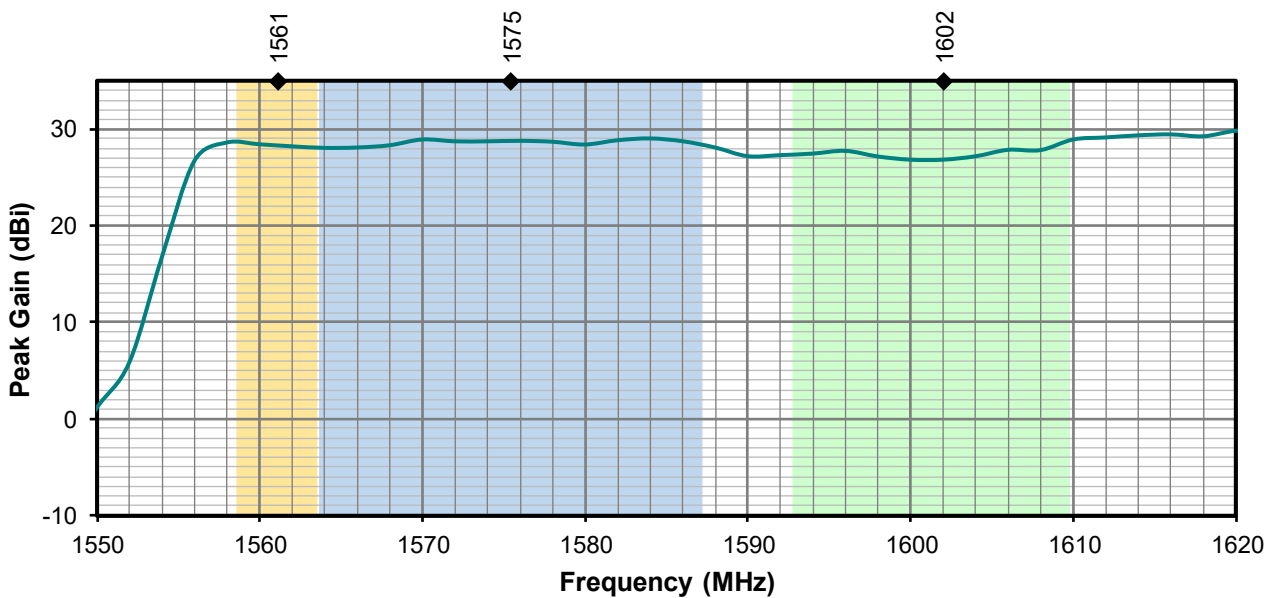

Figure 6. Total Antenna Peak Gain, with ground plane

Axial Ratio

Axial Ratio (**Figure 7**) is the ratio of orthogonal components of an E-field. A circularly polarized field is made up of two orthogonal E-field components of equal amplitude (and 90 degrees out of phase). Axial ratio provides a measure of the quality of antenna circular polarization, the lower the value (in dB), the better the circular polarization. The ideal value of the axial ratio for circularly polarized fields is **0 dB (1)**. In practice, no antenna is perfectly circular in polarization, less than **3 dB** might be an adequate value.

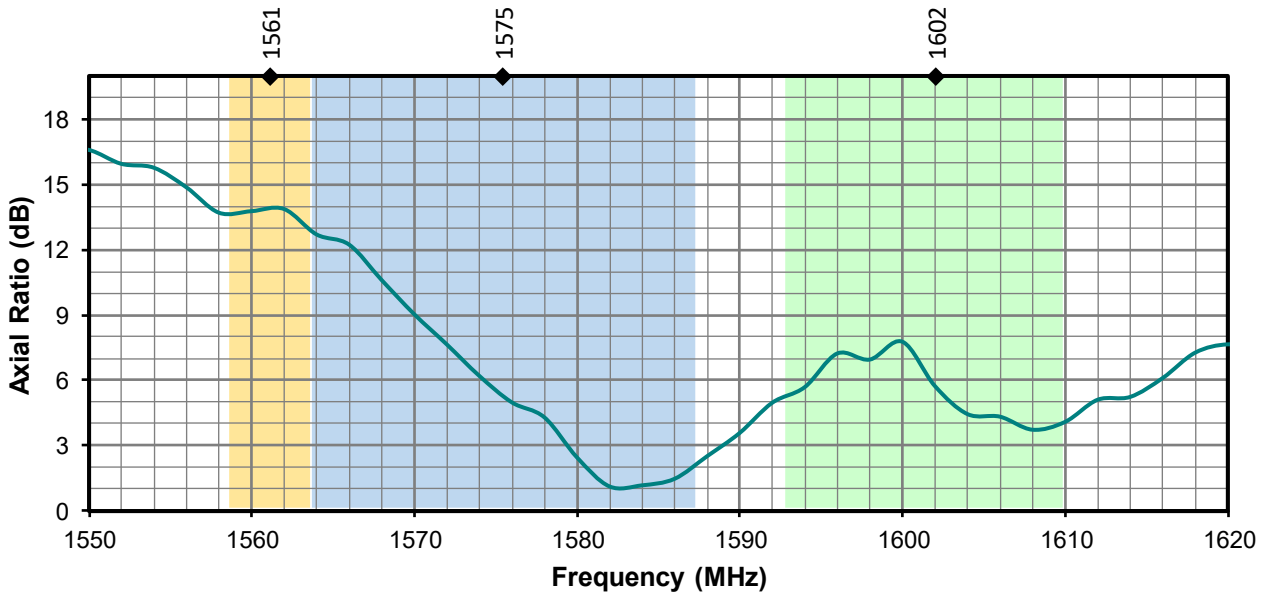

Figure 7. Antenna Axial Ratio, with ground plane

Noise Figure

Noise Factor is the measure of degradation of the signal to noise ratio in a device. It is the ratio of the Signal to Noise Ratio at the input to the Signal to Noise Ratio at the output. The Noise Figure (**Figure 8**) is noise factor expressed in decibels (dB). The lower, the better. Less than **2 dB** might be considered an adequate Noise Figure value.

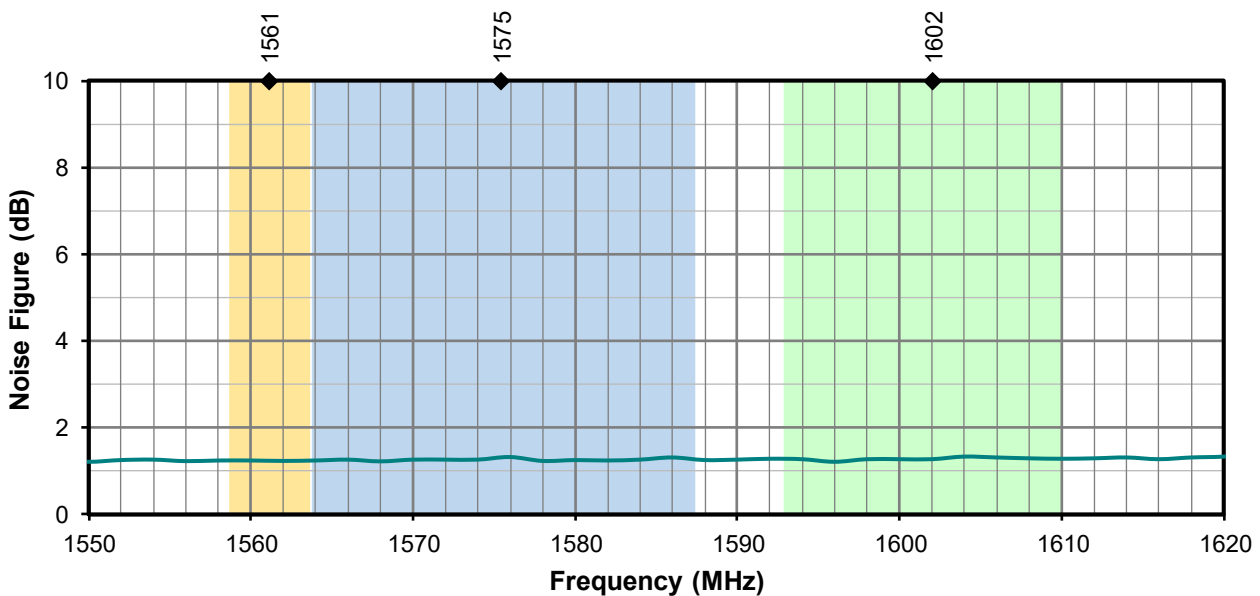
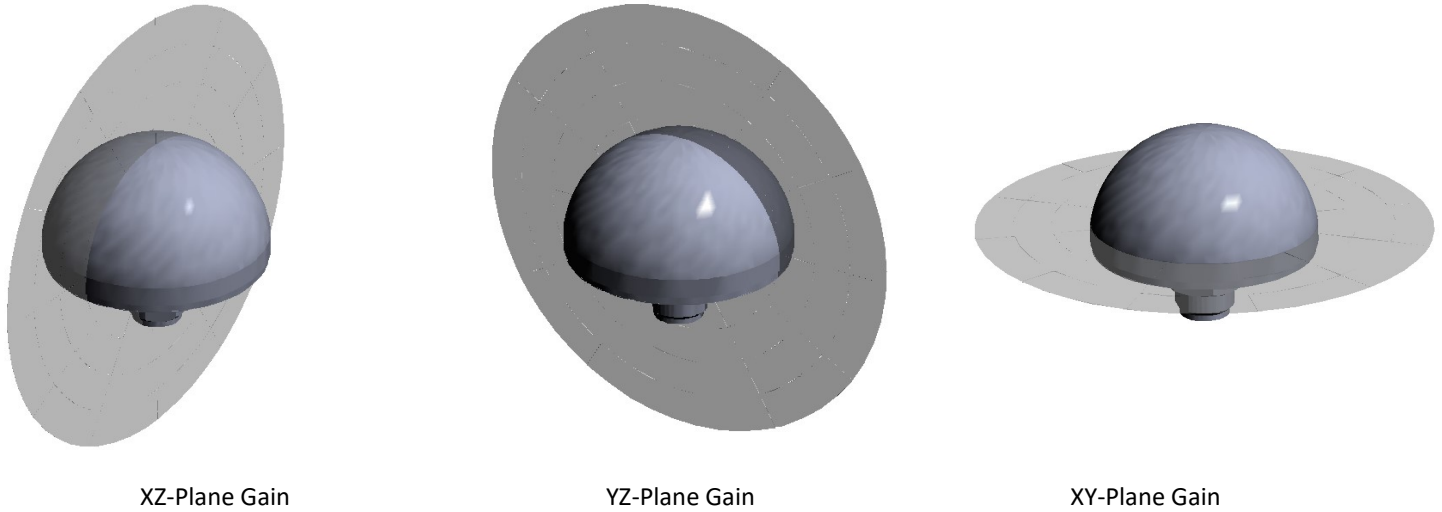

Figure 8. Antenna Noise Figure, with ground plane

Passive Antenna Radiation Patterns

Radiation patterns provide information about the directionality and 3-dimensional gain performance of the antenna by plotting gain at specific frequencies in three orthogonal planes. Antenna radiation patterns for a straight orientation are shown in **Figure 9** using polar plots covering 360 degrees. The antenna graphic at the top of the page provides reference to the plane of the column of plots below it.



1561 MHz to 1602 MHz (1575.42 MHz)

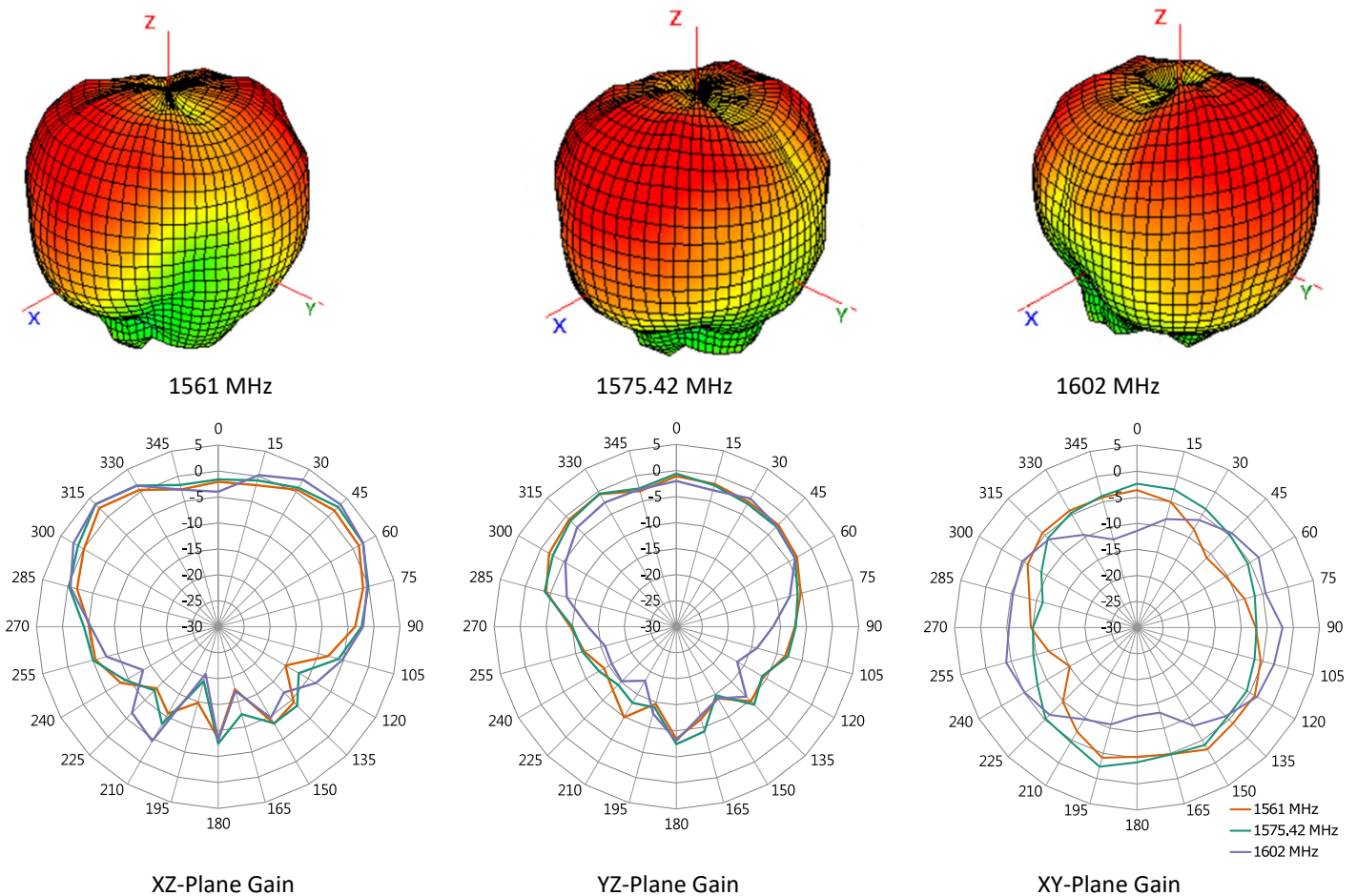

Figure 9. Passive Antenna Radiation Patterns

Antenna FAQs

Q: What is an antenna?

An antenna is used for transmission or reception of radio signals in wireless communication.

Q: How do antennas work?

Electricity flowing into the transmitter antenna makes electrons vibrate up and down it, producing radio waves. The radio waves travel through the air at the speed of light. When the waves arrive at the receiver antenna, they make electrons vibrate inside it.

Q: Does antenna size matter?

A bigger antenna, properly designed, will always have more **gain** than a smaller one. And it will be the best kind of **gain**, much better than using a small antenna and simply over-amplifying it, because a small antenna just won't pull in truly weak signals like this gigantic one will.

Q: What is the advantage of external antennas?

External antennas usually offer **better bandwidth** and **high performance** due to the nature of their larger size. This often results in a higher rated **gain** (dBi) than their internal counterparts. Due to its smaller size, an internal antenna would not function well to support lower frequencies.

Ease of integration – an external antenna requires fewer design resources and shorter time to integrate to allow for a more rapid time-to-market. An internal antenna's performance is influenced by device environment – PCB ground plane, nearby metal part, and enclosure. That would require much more effort such as impedance matching network to complete antenna design

Q: Why is most antenna impedance 50 Ohm?

50 Ohm is an industry standard of coax cables and power amplifiers. It was chosen as a tradeoff between maximum power handling for the transmit coax and the copper losses. The optimum would have been anyway in the range of **30 to 100 ohm** with average at 50 Ohm

Q: Why does GNSS require RHCP (Right-hand-circularly-polarized) antennas?

Satellite's signal has a low power density, especially after propagating through the **atmosphere** (**ionosphere** affect radio wave). Polarized waves oscillate in more than one direction, which deliver satellite's signal to receiver on Earth surface more effectively.

Website: <https://www.joymax.com.tw>
Offices: 5, Dong-Yuan 2nd Road, Zhong-Li Dist., Tao-Yuan City 32063 Taiwan (R.O.C.)
Phone: +886 3 433 5698
E-MAIL: info@joymax.com.tw

Joymax Electronics reserves the right to make changes to the product(s) or information contained herein without notice. No liability is assumed as a result of their use or application. No rights under any patent accompany the sale of any such product(s) or information.

EnJOY MAX Wireless is a registered trademark of Joymax Electronics Co., Ltd. Other product and brand names may be trademarks or registered trademarks of their respective owners.

Copyright © 2024 Joymax Electronics
All Rights Reserved.

01/24 RevA