

## ZGX-1123NX3W

### 5G Outdoor Fiberglass Baton antenna

The Joymax ZGX-1123NX3W antenna is an outdoor baton-style, dipole antenna for 5G New Radio FR1, LTE, and Cellular IoT (LTE-M, NB-IoT) applications with broad bandwidth coverage from 617 MHz to 7125 MHz. The antenna also supports CBRS (3550 MHz to 3700MHz), Public Safety (4940 MHz to 4990 MHz), and a growing number of C-band applications.

The antenna features UV stabilized fiberglass housing, IP67 rated, omnidirectional radiation design, attaches with an N-Type Plug (male pin) connector.



#### Features

- Bandwidth 617M Hz to 7.125 GHz
- Performance at 617 MHz to 698 MHz
  - VSWR:  $\leq 2.1$
  - Peak Gain: 1.1 dBi
  - Efficiency: 59%
- UV Stabilized Fiberglass radome
- IP67 rated
- Omnidirectional radiation
- N-Type Plug (male pin) connector

#### Applications

- 5G NR FR1, 4G, 3G, 2G, CBRS
- Cellular IoT: LTE-M (Cat-M1), NB-IoT
- CBRS Private Network (3550 to 3700MHz)
- C-Band applications (3700 to 4200MHz)
- Public Safety networks (4940 to 4990MHz)
- Internet of Things (IoT) devices
- Networking routers / gateways
- Small base station

#### Ordering Information

Part Number	Description
<b>ZGX-1123NX3W</b>	5G/LTE Cellular Outdoor Fiberglass baton antenna w. N Plug (male pin) Connector

Available from Joymax Electronics and select distributors and representatives.

**Table 1: Electrical Specifications**

ZGX-1123NX3W	5G NR / LTE Bands (MHz)					
Frequency Range	617~960	1710~2690	3300~4200	4400~5000	5150~5850	5925-7125
VSWR (Max)	2.1	2.5	2.3	3.0	2.4	2.0
Peak Gain (dBi)	2.7	3.4	2.2	3.6	4.0	4.5
Average Gain (dBi)	-2.6	-1.9	-1.7	-2.6	-2.4	-2.7
Efficiency (%)	55	65	68	56	58	55
Polarization	Linear					
Radiation	Omni directional					
Max Power	10 W					
Wavelength	$\frac{1}{2}\lambda$					
Electrical Type	Dipole					
Impedance	50 $\Omega$					

Electrical specifications and plots measured with the antenna in a free space without ground plane.

**Table 2: Mechanical Specifications**

Parameter	Value
Connection	N-Type Plug (male pin) connector
Operating Temp.	-40°C to +85°C
Weight	80 g
Dimension	152 mm x $\varnothing$ 24 mm
Antenna Color	White
Ingress Protection	IP67

## Packaging Information

The ZGX-1123NX3W antennas are individually sealed in a clear plastic bag and a small box. **Figure 1.** 100 pcs per carton, 320 mm x 250 mm x 290 mm (12.5 in x 9.8 in x 11.4 in), total weight 9 kgs (19.8 lb) Distribution channels may offer alternative packaging options.



1 pc antenna/ 1 Box

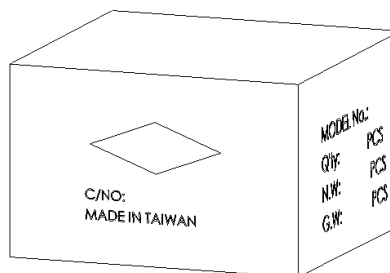

100 pcs antenna/ 1 Carton

**Figure 1. Antenna Packaging**

## Product Dimensions

**Figure 2** provides dimensions of the ZGX-1123NX3W. The baton/stick antenna can be directly mounted on enclosure-mounted connector with N-Type plug (male pin) connector.

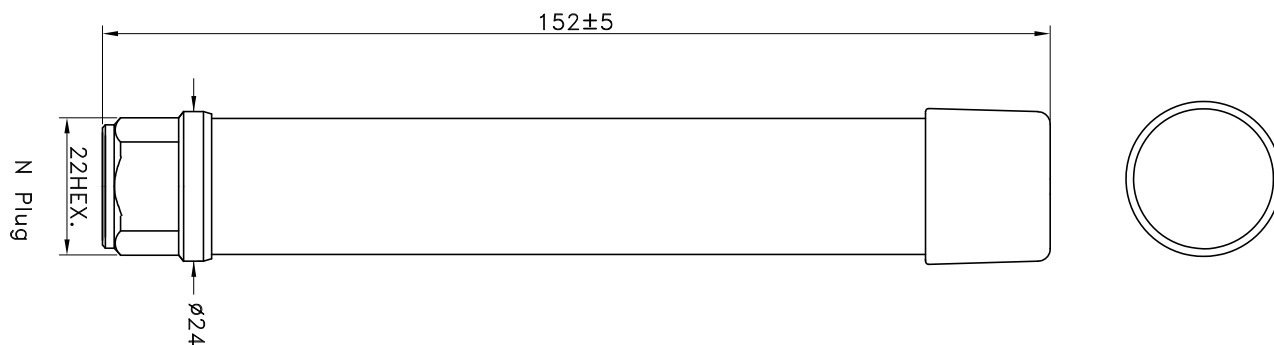

**Figure 2. Antenna Dimensions**

## Antenna Orientation

The ZGX-1123NX3W antenna is characterized in straight antenna orientation as shown in **Figure 3**. The antenna orientation characterizes use of antenna attached to enclosure-mounted connector. The charts on the following pages represent data taken with the antenna in free space without ground plane.



**Figure 3. Antenna Test Orientation**

### VSWR

**Figure 4** provides the voltage standing wave ratio (VSWR) across the antenna bandwidth. VSWR is a function of the reflection coefficient, which describes the power reflected from the antenna back to the radio. A lower VSWR value indicates better antenna performance at a given frequency. Reflected power is also shown on the right-side vertical axis as a gauge of the percentage of transmitter power reflected back from the antenna.

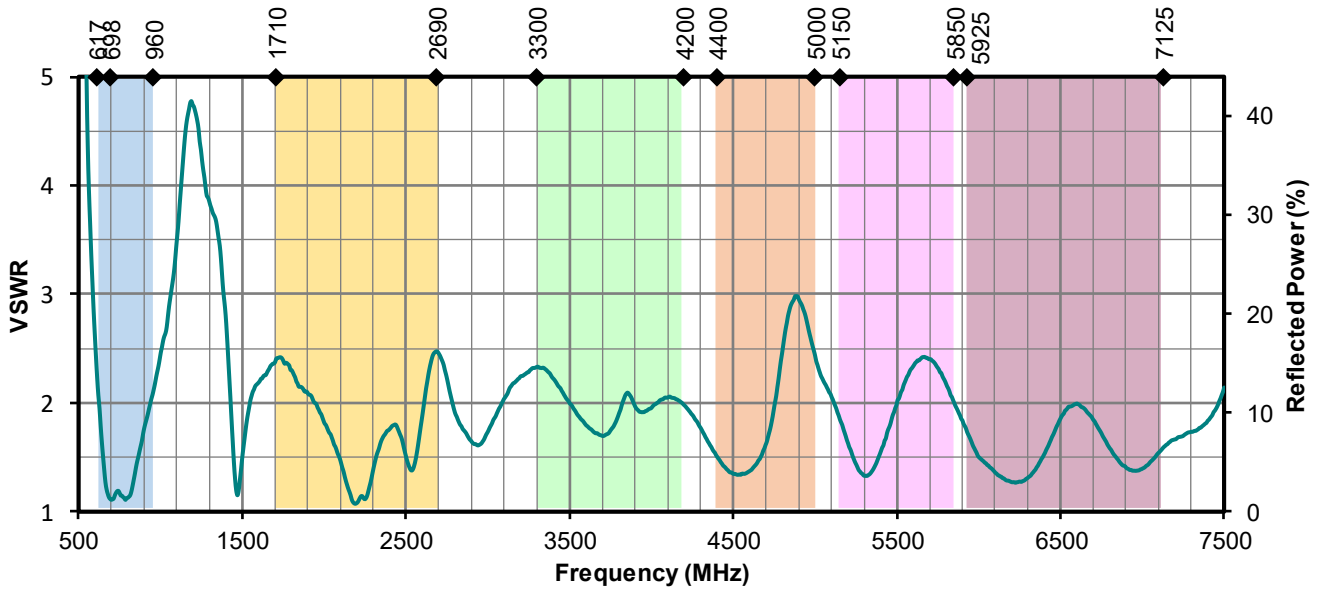

**Figure 4. Antenna VSWR, Straight without ground plane**

### Return Loss

Return loss (**Figure 5**), represents the loss in power at the antenna due to reflected signals. Like VSWR, a lower return loss value indicates better antenna performance at a given frequency.

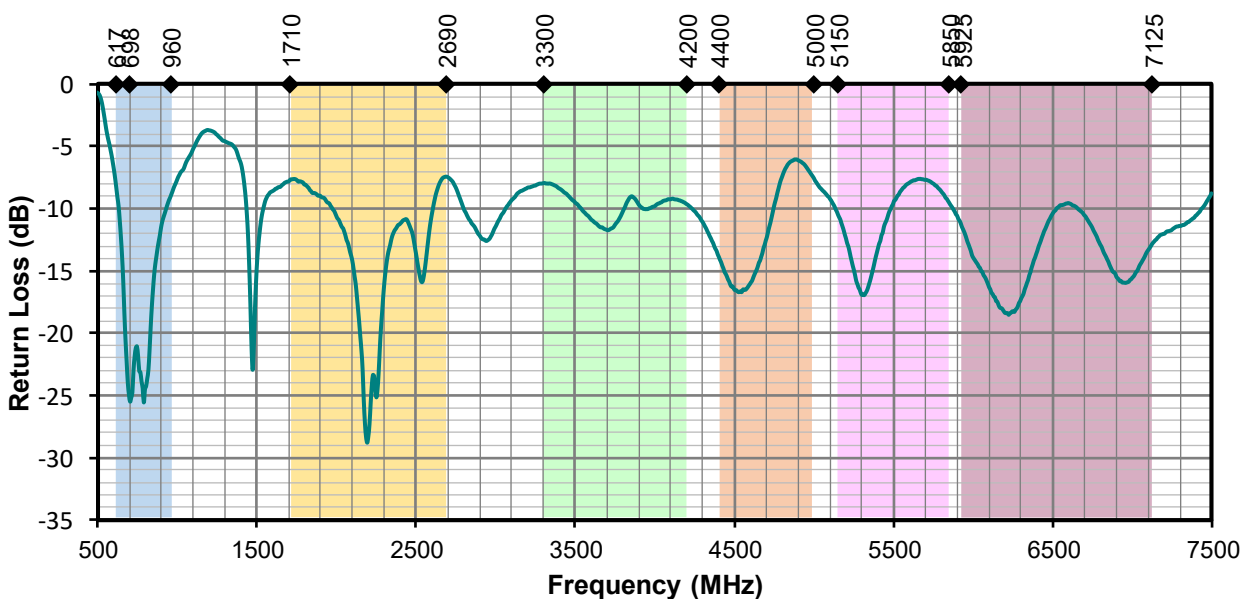

**Figure 5. Antenna Return Loss, Straight without ground plane**

### Peak Gain

The peak gain across the antenna bandwidth is shown in **Figure 6**. Peak gain represents the maximum antenna input power concentration across 3-dimensional space, and therefore peak performance at a given frequency, but does not consider any directionality in the gain pattern.

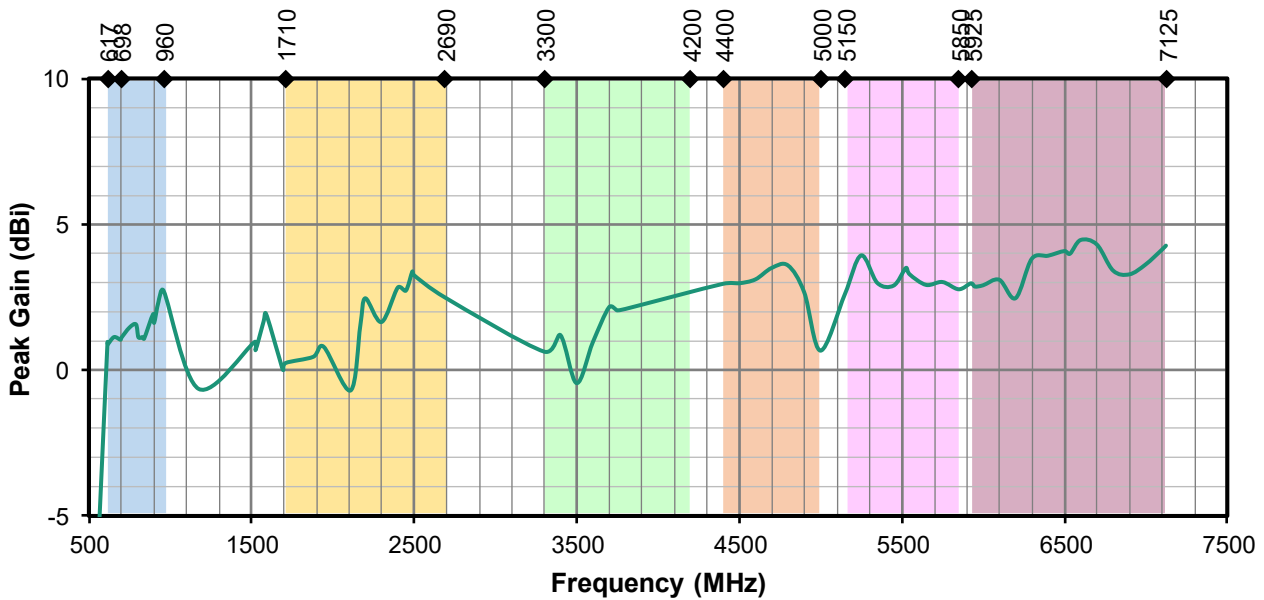

Figure 6. Antenna Peak Gain, Straight without ground plane

### Average Gain

Average gain (**Figure 7**), is the average of all antenna gain in 3-dimensional space at each frequency, providing an indication of overall performance without expressing antenna directionality.

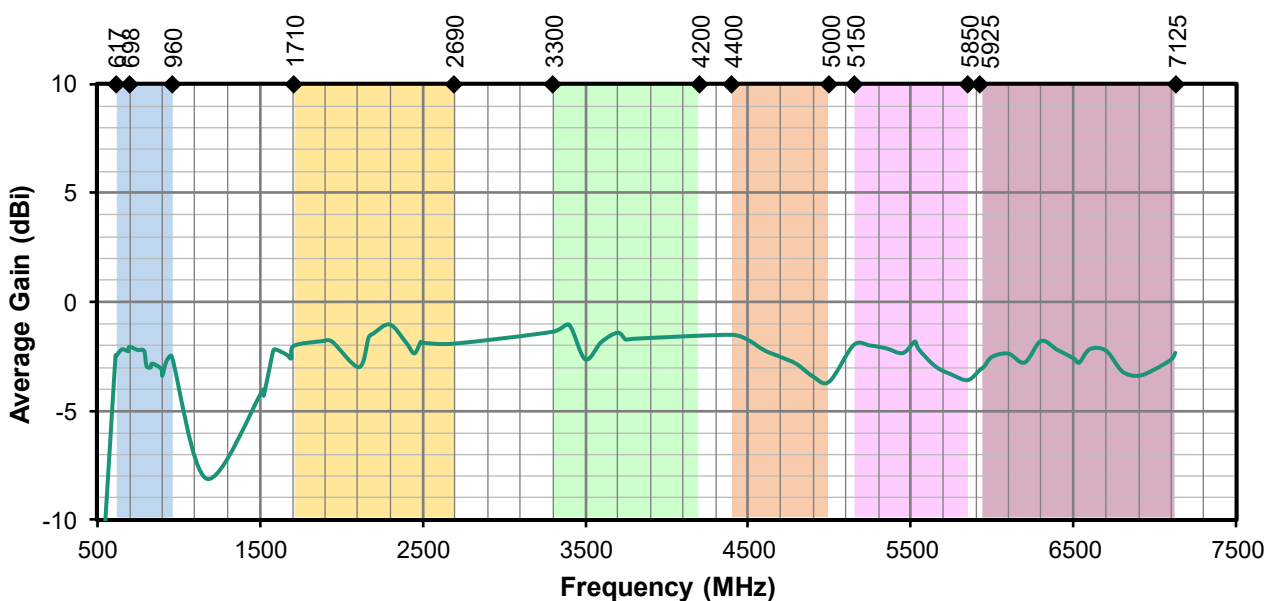
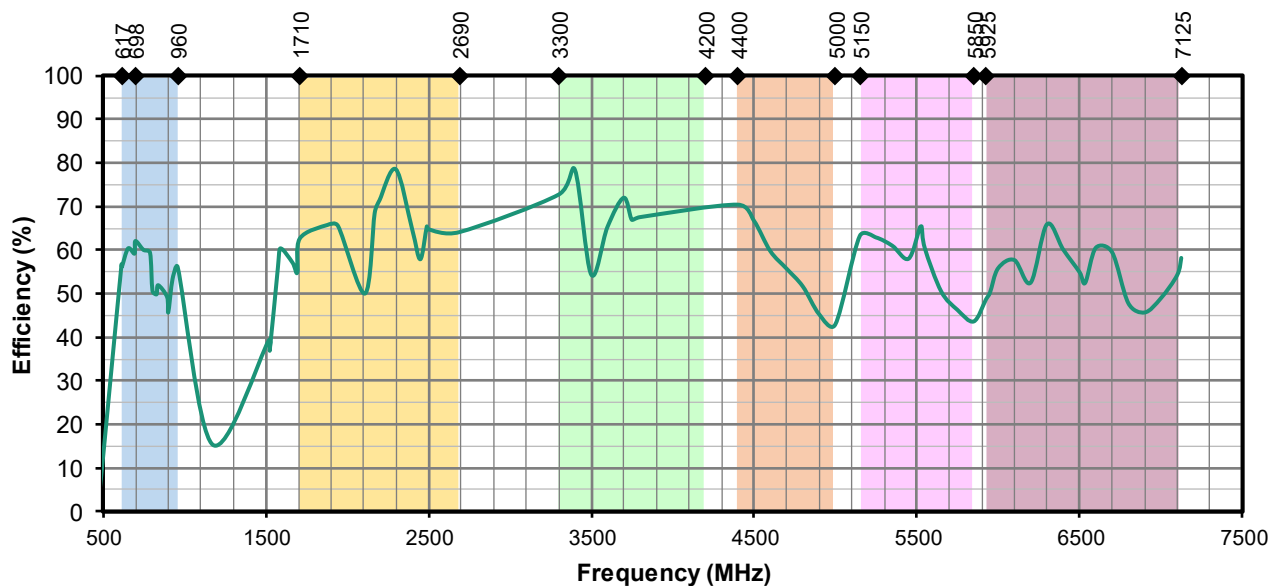

Figure 7. Antenna Average Gain, Straight without ground plane

### Radiation Efficiency

Radiation efficiency (**Figure 8**), shows the ratio of power radiated by the antenna relative to the power supplied to the antenna, expressed as a percentage, where a higher percentage indicates better performance at a given frequency. An ideal antenna has 100% efficiency. But in really world, usually an external antenna radiates only 50~60% of power supplied to it.



**Figure 8. Antenna Efficiency, Straight without ground plane**

### Radiation Patterns

Radiation patterns provide information about the directionality and 3-dimensional gain performance of the antenna by plotting gain at specific frequencies in three orthogonal planes. Antenna radiation patterns for a straight orientation are shown in **Figure 9** using polar plots covering 360 degrees. The antenna graphic at the top of the page provides reference to the plane of the column of plots below it.

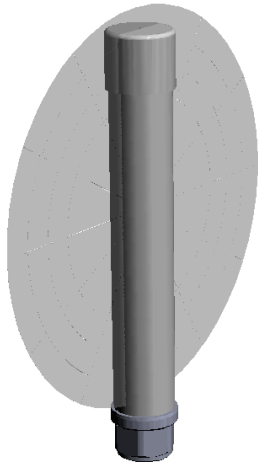

XZ-Plane Gain

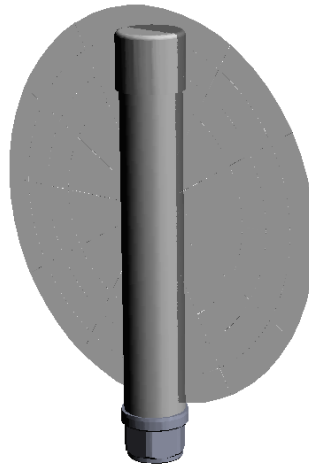

YZ-Plane Gain

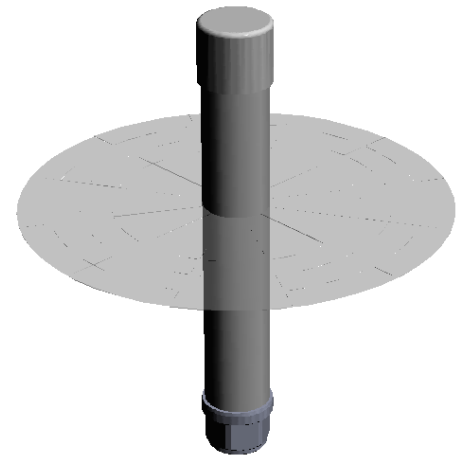

XY-Plane Gain

### 617 MHz to 960 MHz (778 MHz)

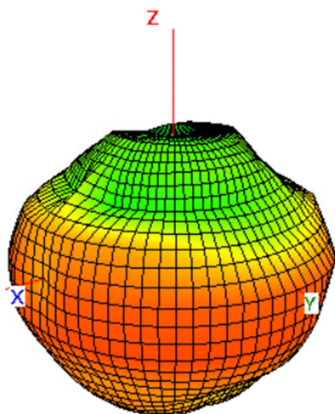

617 MHz

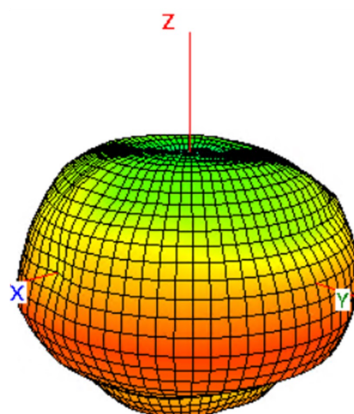

778 MHz

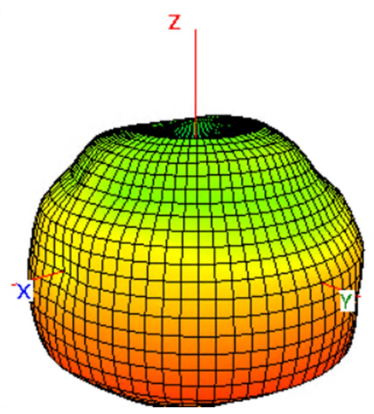

960 MHz

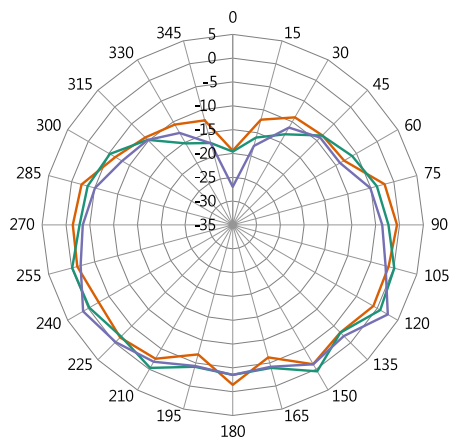

XZ-Plane Gain

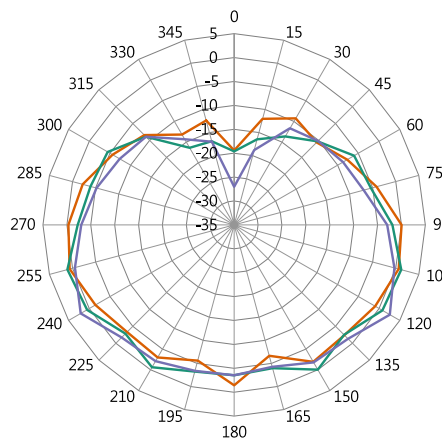

YZ-Plane Gain

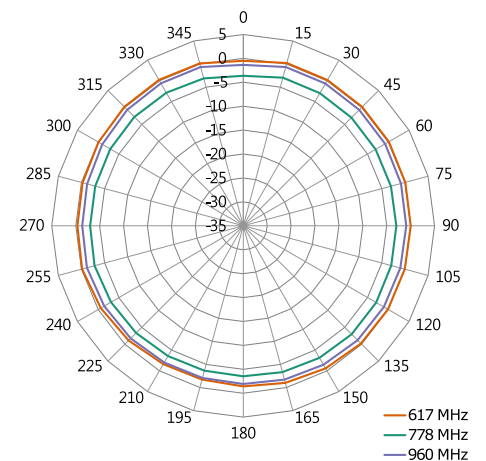

XY-Plane Gain

Figure 9. Antenna Radiation Patterns, Straight without ground plane



1710 MHz to 5000 MHz (3355 MHz)

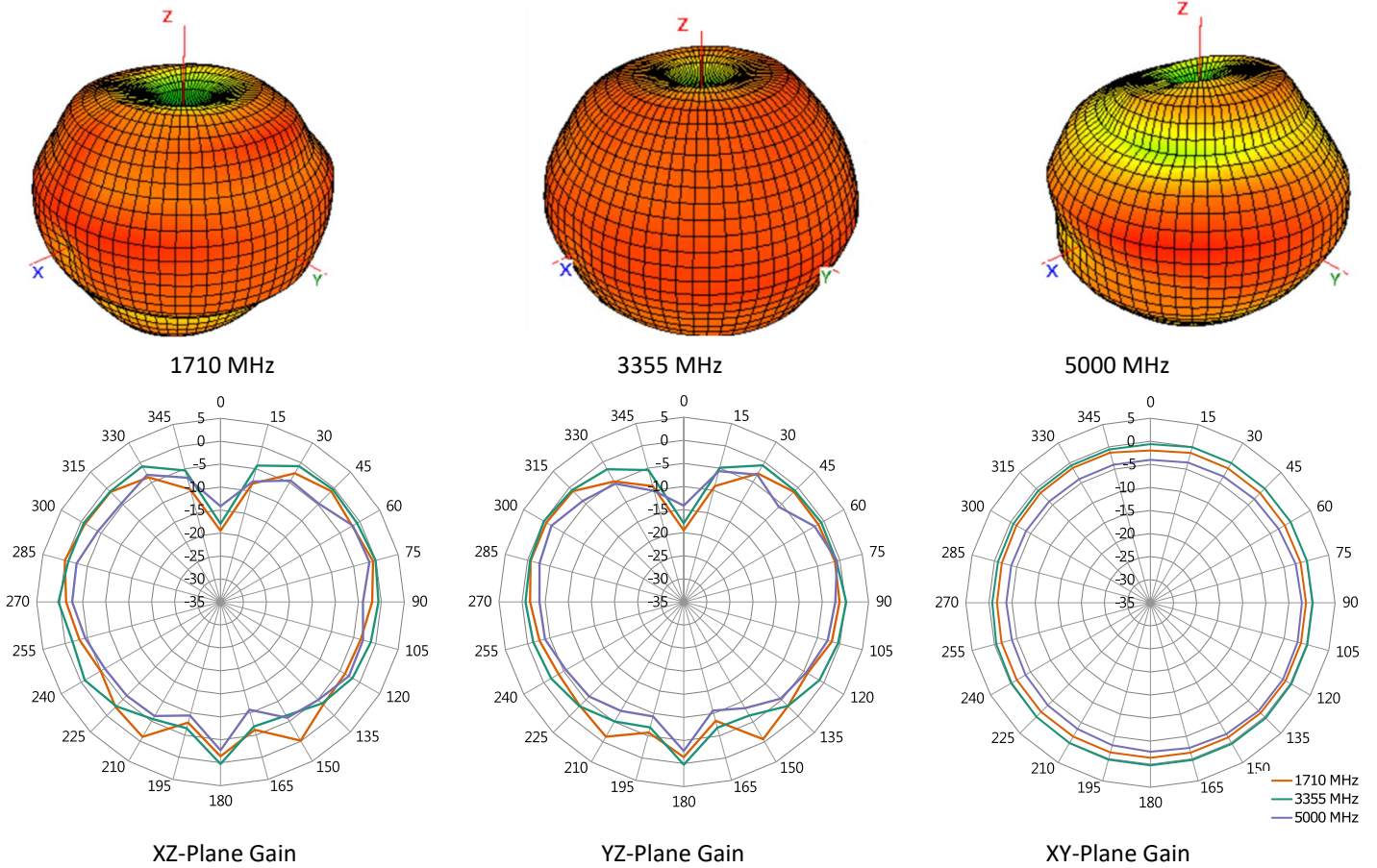

5150 MHz to 5850 MHz (5550 MHz)

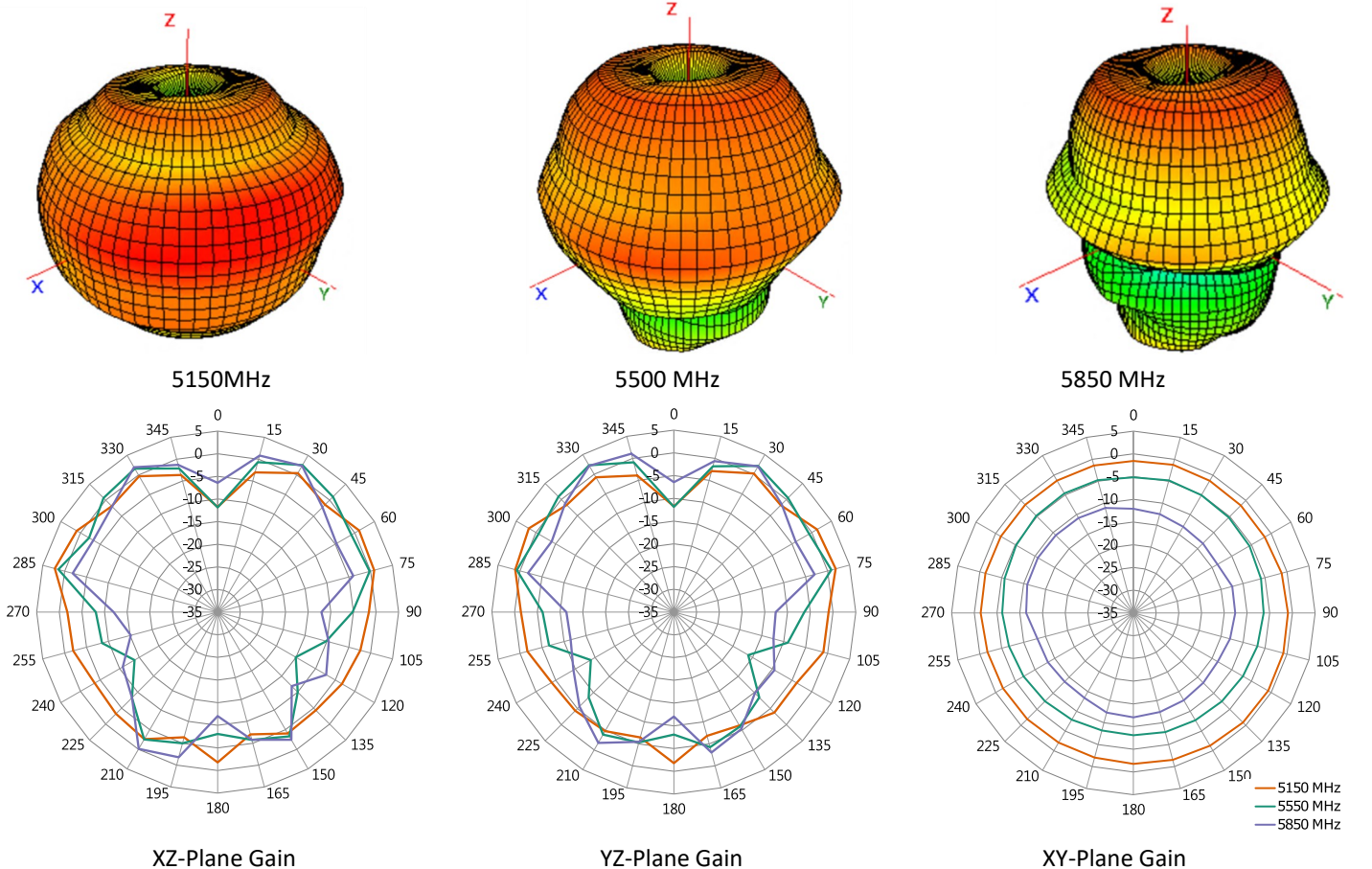

Figure 9-1. Antenna Radiation Patterns, Straight without ground plane



5925 MHz to 7125 MHz (6525 MHz)

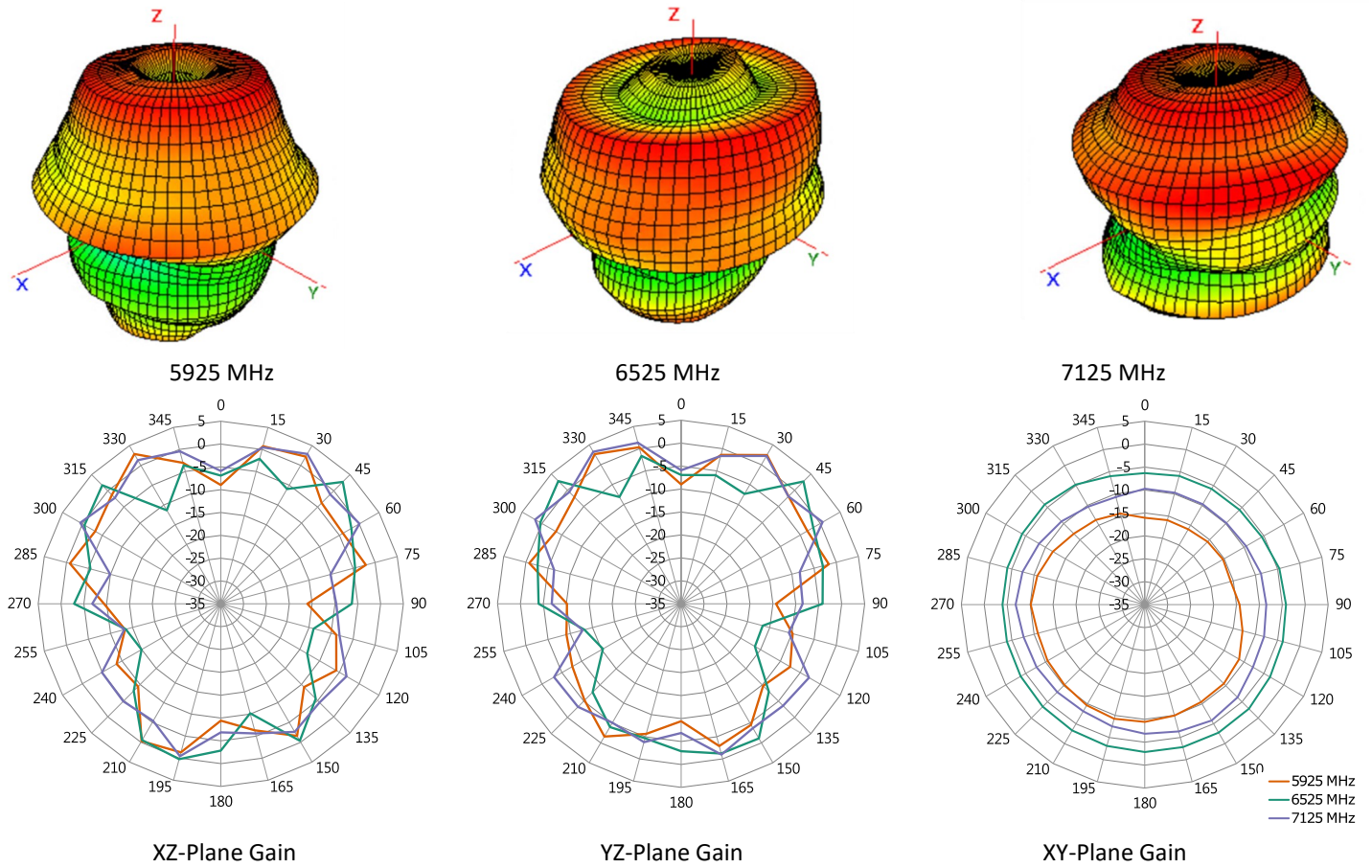

Figure 9-2. Antenna Radiation Patterns, Straight without ground plane

## Antenna FAQs

### Q: What is an antenna?

An antenna is used for transmission or reception of radio signals in wireless communication.

### Q: How do antennas work?

Electricity flowing into the transmitter antenna makes electrons vibrate up and down it, producing radio waves. The radio waves travel through the air at the speed of light. When the waves arrive at the receiver antenna, they make electrons vibrate inside it.

### Q: Does antenna size matter?

A bigger antenna, properly designed, will always have more **gain** than a smaller one. And it will be the best kind of **gain**, much better than using a small antenna and simply over-amplifying it, because a small antenna just won't pull in truly weak signals like this gigantic one will.

### Q: What is the advantage of external antennas?

External antennas usually offer **better bandwidth** and **high performance** due to the nature of their larger size. This often results in a higher rated **gain** (dBi) than their internal counterparts. Due to its smaller size, an internal antenna would not function well to support lower frequencies.

Ease of integration – an external antenna requires fewer design resources and shorter time to integrate to allow for a more rapid time-to-market. An internal antenna's performance is influenced by device environment – PCB ground plane, nearby metal part, and enclosure. That would require much more effort such as impedance matching network to complete antenna design

### Q: Why is most antenna impedance 50 Ohm?

50 Ohm is an industry standard of coax cables and power amplifiers. It was chosen as a tradeoff between maximum power handling for the transmit coax and the copper losses. The optimum would have been anyway in the range of **30 to 100 ohm** with average at 50 Ohm

### Q: Why does GNSS require RHCP (Right-hand-circularly-polarized) antennas?

Satellite's signal has a low power density, especially after propagating through the **atmosphere** (**ionosphere** affect radio wave). Polarized waves oscillate in more than one direction, which deliver satellite's signal to receiver on Earth surface more effectively.

---

Website: <https://www.joymax.com.tw>  
Offices: 5, Dong-Yuan 2<sup>nd</sup> Road, Zhong-Li Dist., Tao-Yuan City 32063 Taiwan (R.O.C.)  
Phone: +886 3 433 5698  
E-MAIL: [info@joymax.com.tw](mailto:info@joymax.com.tw)

---

Joymax Electronics reserves the right to make changes to the product(s) or information contained herein without notice. No liability is assumed as a result of their use or application. No rights under any patent accompany the sale of any such product(s) or information.

EnJOY MAX Wireless is a registered trademark of Joymax Electronics Co., Ltd. Other product and brand names may be trademarks or registered trademarks of their respective owners.

Copyright © 2024 Joymax Electronics  
All Rights Reserved.

01/24 RevA