

## IWX-282BccXB

### 2.4 GHz ISM Whip antenna

The Joymax IWX-282BccXB antenna is a whip-style, dipole antenna designed for use in 2.4 GHz ISM band supporting Bluetooth®, ZigBee®, Thread®, IEEE 802.15.4, IEEE 802.11b/g and other unlicensed band application.

The tilt/swivel design allows the antenna to be positioned for optimum performance and reduces the potential for damage from impact compared to a fixed whip design. The antenna attaches with an SMA plug (male pin) or RP-SMA Plug (female socket) connector.



#### Features

- Bandwidth 2400 MHz to 2500 MHz
- Performance at 2400 MHz to 2500 MHz
  - VSWR:  $\leq 1.6$
  - Peak Gain: 2.4 dBi
  - Efficiency: 72%
- Hinged design with detents for straight, 45 degree and 90 degree positioning
- SMA plug (male pin) or RP-SMA plug (female socket)

#### Applications

- ISM applications:
  - Bluetooth®
  - ZigBee®
  - Thread®
  - IEEE 802.15.4
  - IEEE 802.11b/g
- Internet of Things (IoT) devices
- Networking routers / gateways

#### Ordering Information

Part Number	Description
<b>IWX-282BRSXB</b>	2.4 GHz ISM Tilt/Swivel Whip Antenna with RP-SMA plug (female socket) connector
<b>IWX-282BSAXB</b>	2.4 GHz ISM Tilt/Swivel Whip Antenna with SMA plug (male pin) connector

Available from Joymax Electronics and select distributors and representatives.

**Table 1: Electrical Specifications**

IWX-282BccXB	2.4 GHz ISM (MHz)		
	2400 MHz	2450 MHz	2500 MHz
Frequency Range	2400 MHz	2450 MHz	2500 MHz
VSWR (Max)	1.3	1.2	1.6
Peak Gain (dBi)	2.1	2.3	2.4
Average Gain (dBi)	-1.8	-1.5	-1.3
Efficiency (%)	66	71	74
Polarization	Linear		
Radiation	Omni directional		
Max Power	1 W		
Wavelength	$\frac{1}{2}\lambda$		
Electrical Type	Dipole		
Impedance	50 $\Omega$		

Electrical specifications and plots measured with the antenna in a straight orientation without ground plane.

**Table 2: Mechanical Specifications**

Parameter	Value
Connection	SMA Plug (male pin) or RP-SMA Plug (female socket)
Operating Temp.	-30°C to +70°C
Weight	8 g
Dimension	84 mm (Straight) x $\phi$ 10 mm
Antenna Color	Black
Ingress Protection	N/A

## Packaging Information

The IWX-282BccXB antennas are individually sealed in a clear plastic bag. **Figure 1.** 1000 pcs per carton, 320 mm x 250 mm x 230 mm (12.5 in x 9.8 in x 9.0 in), total weight 7.87 kgs (17.35 lb) Distribution channels may offer alternative packaging options.

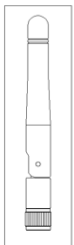

1 pce antenna/ 1 PE bag

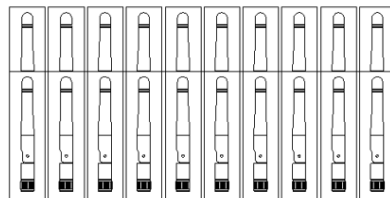

50 pcs antenna/ 1 Bigger PE bag

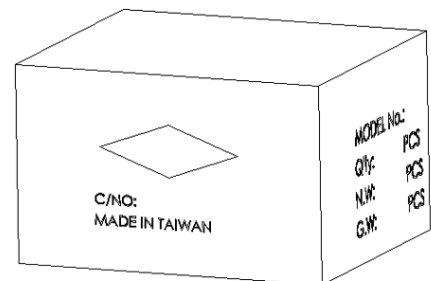

1000 pcs antenna/1 Carton

**Figure 1. Antenna Packaging**

## Product Dimensions

**Figure 2** provides dimensions of the IWX-282BccXB. The antenna blade can be tilted 90 degrees, and has a detent at 45 degrees enabling the antenna to be oriented in any direction. The rotating base allows for continuous positioning through 360 degrees even while installed.

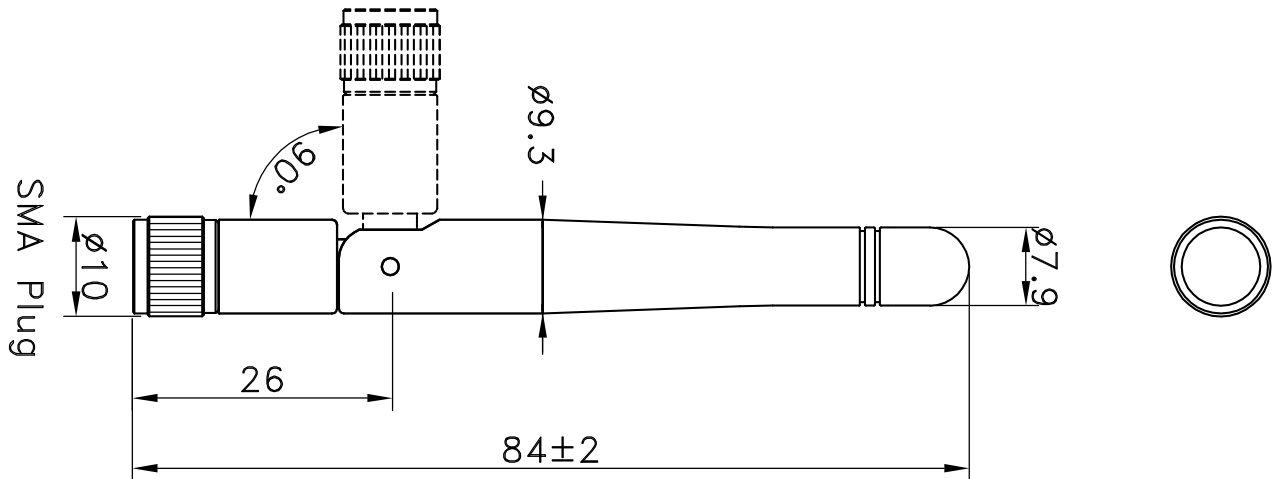

**Figure 2. Antenna Dimensions**

## Antenna Orientation

The IWX-282BccXB antenna is characterized in two antenna orientations as shown in **Figure 3**. The antenna straight orientation characterizes use of an antenna attached to an enclosure-mounted connector which is connected by cable to the VNA. Although the antenna is a dipole not requiring a ground plane for function, characterization with an adjacent ground plane (120 mm x 120 mm) provides insight into antenna performance when attached directly to a printed circuit board mounted connector. The two orientations represent the most common end-product use cases.

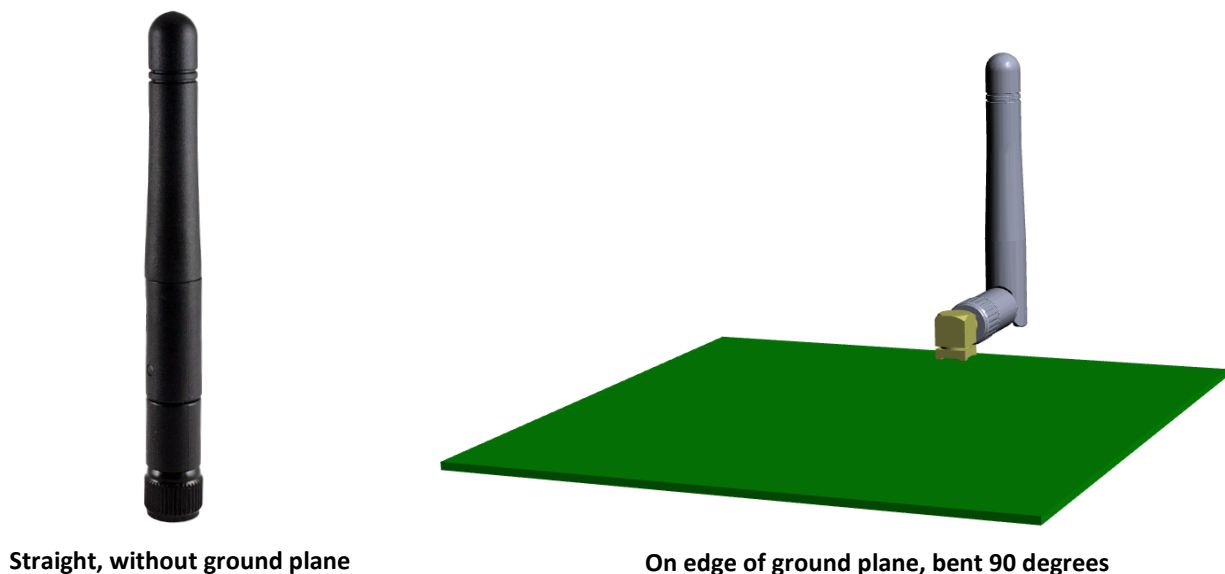

**Figure 3. Antenna Test Orientation**

### STRAIGHT, NO GROUND PLANE

The charts on the following pages represent data taken with the antenna oriented straight, as shown in Figure 4.



Figure 4. Straight orientation, No ground plane

### VSWR

Figure 5 provides the voltage standing wave ratio (VSWR) across the antenna bandwidth. VSWR is a function of the reflection coefficient, which describes the power reflected from the antenna back to the radio. A lower VSWR value indicates better antenna performance at a given frequency. Reflected power is also shown on the right-side vertical axis as a gauge of the percentage of transmitter power reflected back from the antenna.

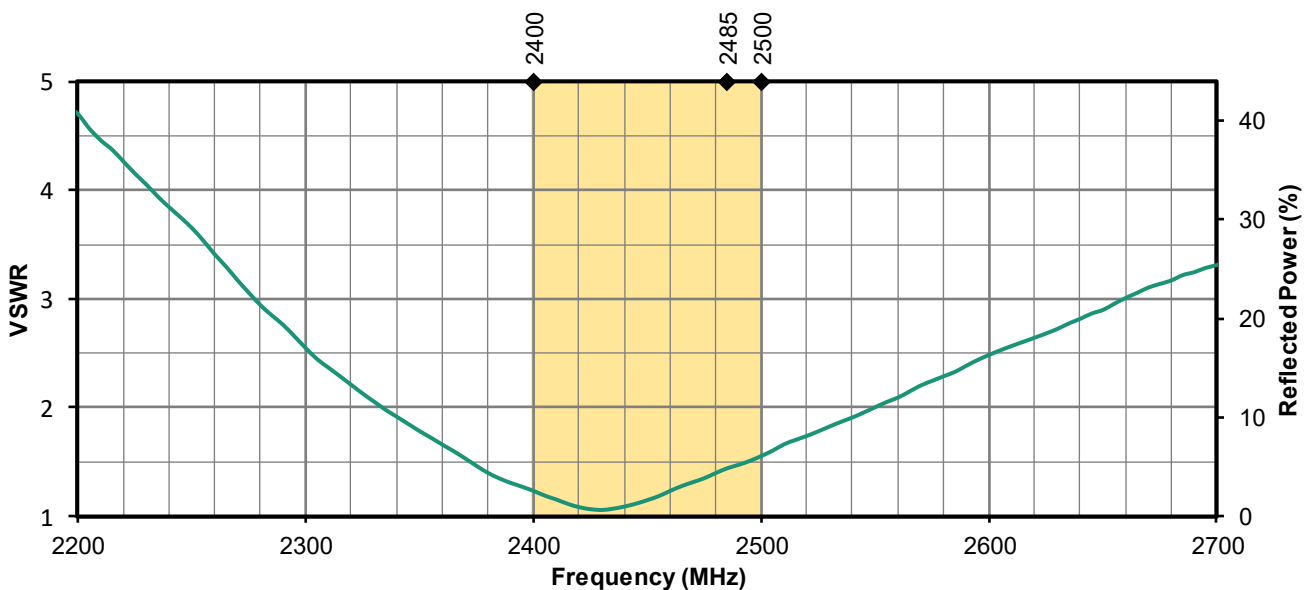

Figure 5. Antenna VSWR, Straight, No ground plane

### Return Loss

Return loss (**Figure 6**), represents the loss in power at the antenna due to reflected signals. Like VSWR, a lower return loss value indicates better antenna performance at a given frequency.

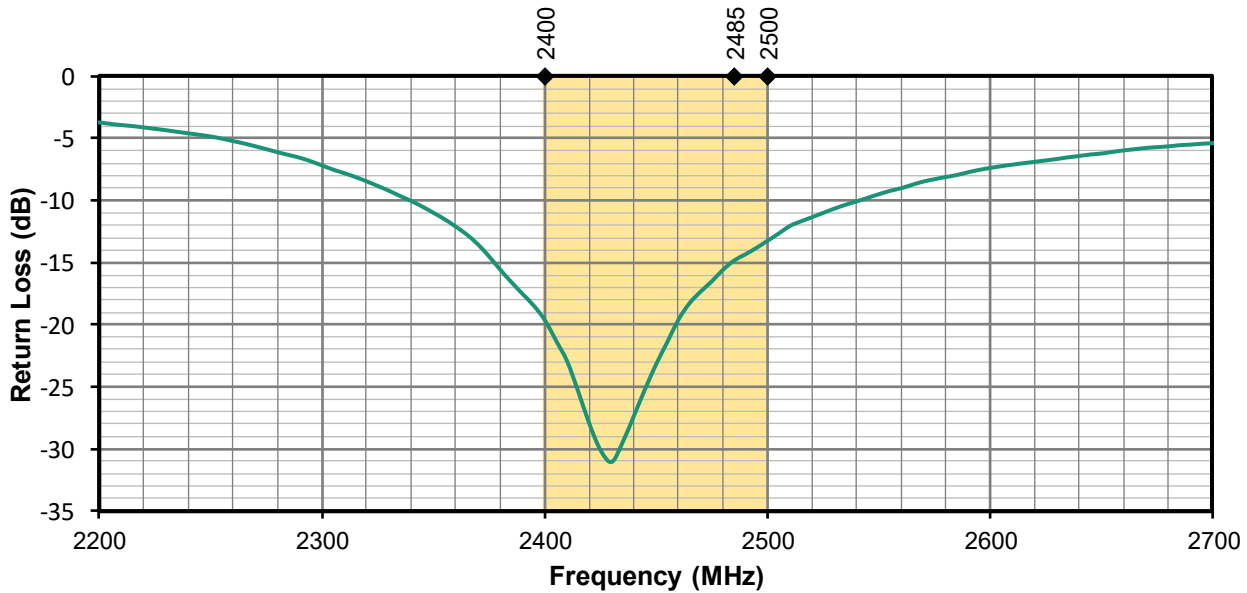

Figure 6. Antenna Return Loss, Straight, No ground plane

### Peak Gain

The peak gain across the antenna bandwidth is shown in **Figure 7**. Peak gain represents the maximum antenna input power concentration across 3-dimensional space, and therefore peak performance at a given frequency, but does not consider any directionality in the gain pattern.

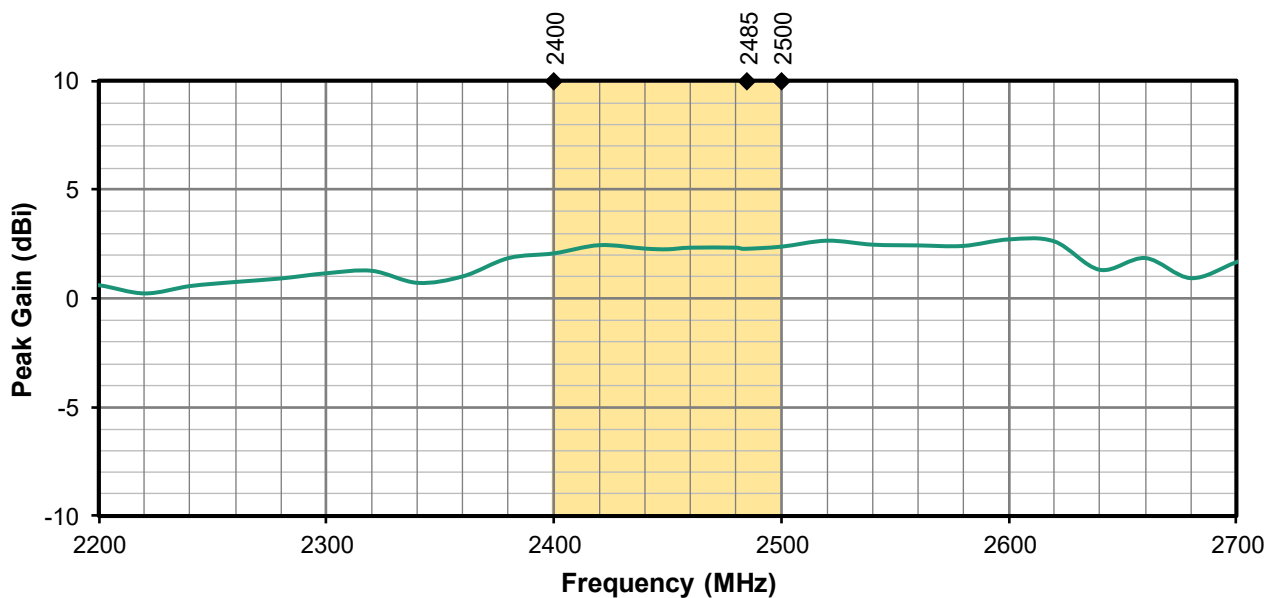

Figure 7. Antenna Peak Gain, Straight, No ground plane

## Average Gain

Average gain (**Figure 8**), is the average of all antenna gain in 3-dimensional space at each frequency, providing an indication of overall performance without expressing antenna directionality.

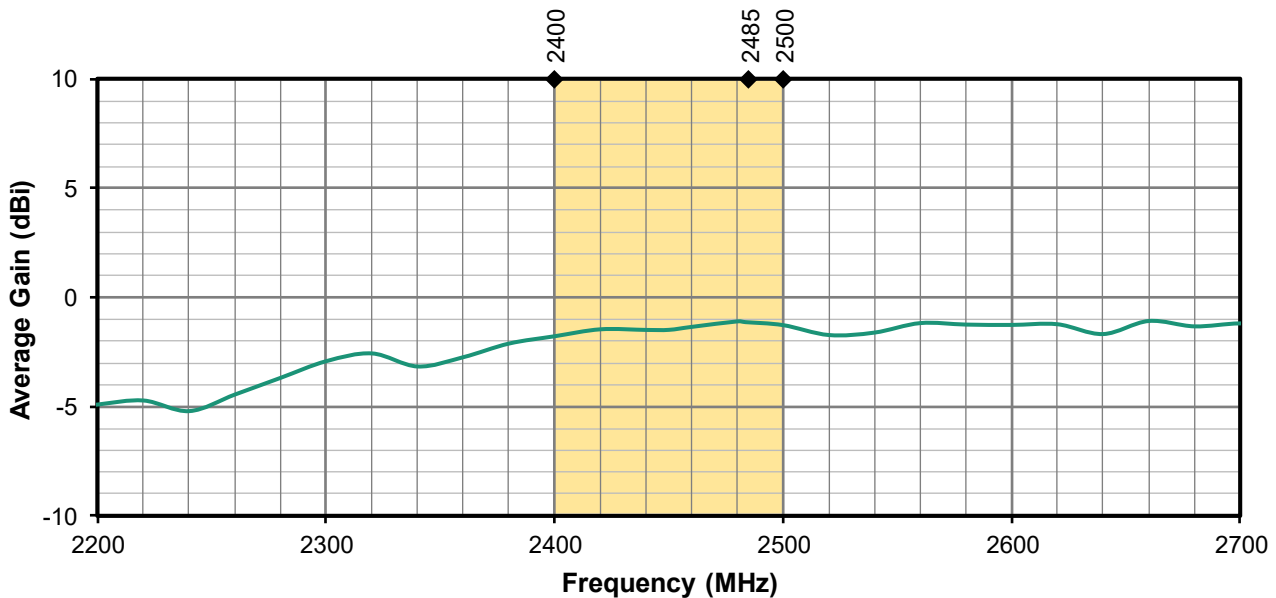

Figure 8. Antenna Average Gain, Straight, No ground plane

## Radiation Efficiency

Radiation efficiency (**Figure 9**), shows the ratio of power radiated by the antenna relative to the power supplied to the antenna, expressed as a percentage, where a higher percentage indicates better performance at a given frequency. An ideal antenna has 100% efficiency. But in really world, usually an external antenna radiates only 50~60% of power supplied to it.

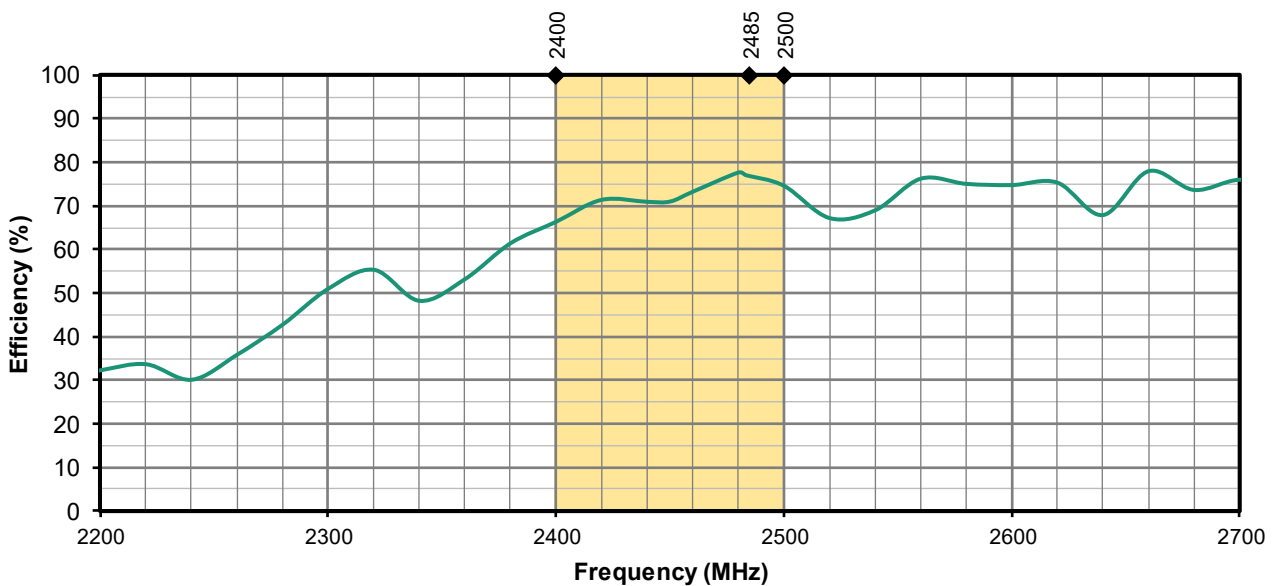

Figure 9. Antenna Efficiency, Straight, No ground plane

### Radiation Patterns

Radiation patterns provide information about the directionality and 3-dimensional gain performance of the antenna by plotting gain at specific frequencies in three orthogonal planes. Antenna radiation patterns for a straight orientation are shown in **Figure 10** using polar plots covering 360 degrees. The antenna graphic at the top of the page provides reference to the plane of the column of plots below it.



XZ-Plane Gain



YZ-Plane Gain

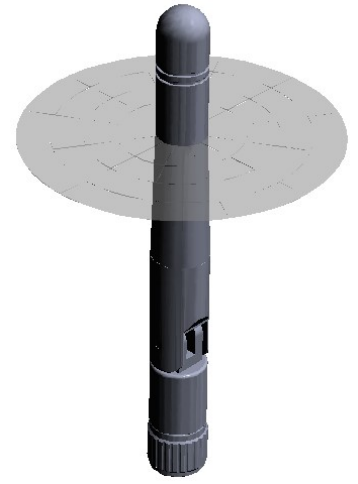

XY-Plane Gain

### 2400 MHz to 2500 MHz (2450 MHz)

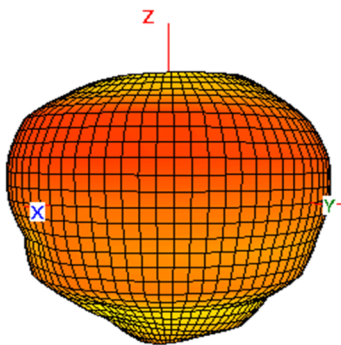

2400 MHz

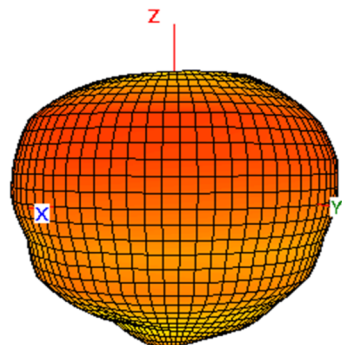

2450 MHz

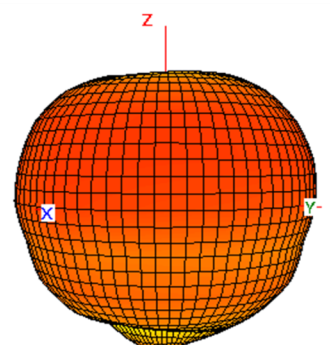

2500 MHz

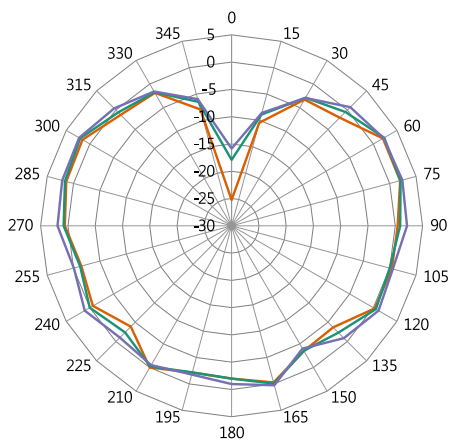

XZ-Plane Gain

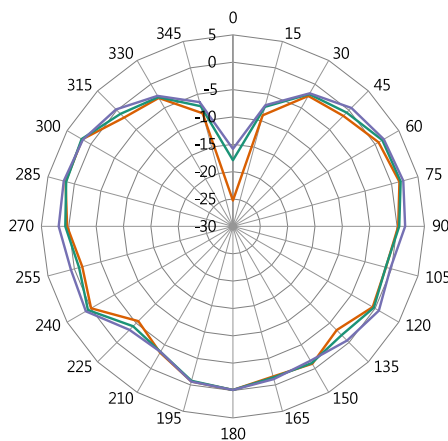

YZ-Plane Gain

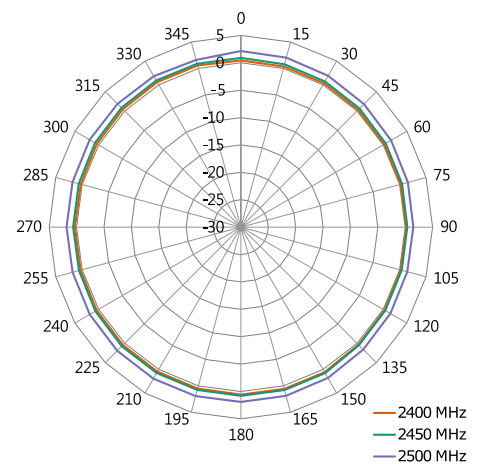

XY-Plane Gain

**Figure 10. Antenna Radiation Patterns, Straight, No ground plane**

## EDGE OF GROUND PLANE, BENT 90 DEGREES

The charts on the following pages represent data taken with the antenna oriented at the edge of the ground plane, bent 90 degrees (Edge-Bent), as shown in **Figure 11**.

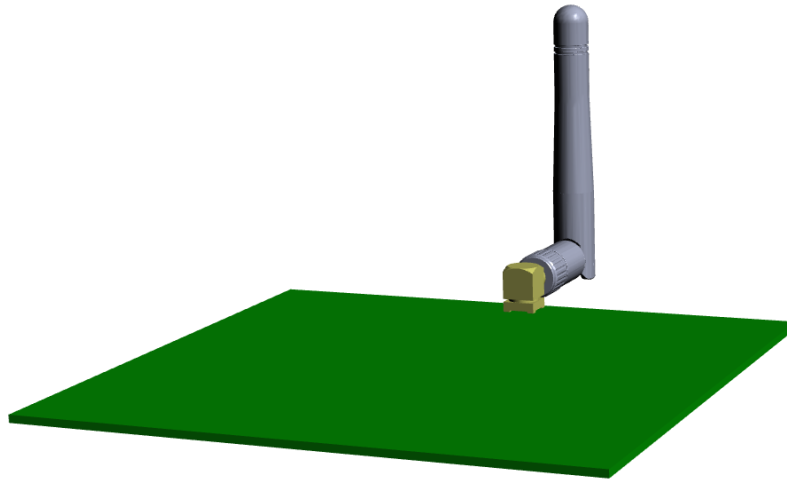

**Figure 11. On edge of ground plane, Bent 90 Degrees**

### VSWR

**Figure 12** provides the voltage standing wave ratio (VSWR) across the antenna bandwidth. VSWR is a function of the reflection coefficient, which describes the power reflected from the antenna back to the radio. A lower VSWR value indicates better antenna performance at a given frequency. Reflected power is also shown on the right-side vertical axis as a gauge of the percentage of transmitter power reflected back from the antenna.

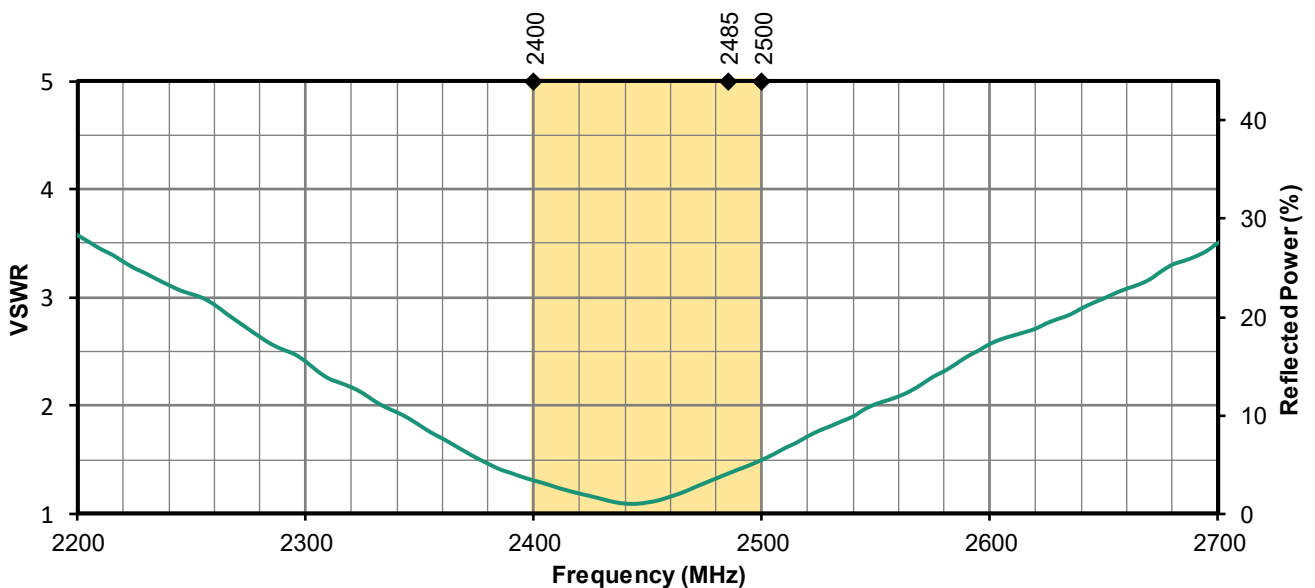

**Figure 12. Antenna VSWR, Edge Bent 90 Degrees**



## Return Loss

Return loss (**Figure 13**), represents the loss in power at the antenna due to reflected signals. Like VSWR, a lower return loss value indicates better antenna performance at a given frequency.

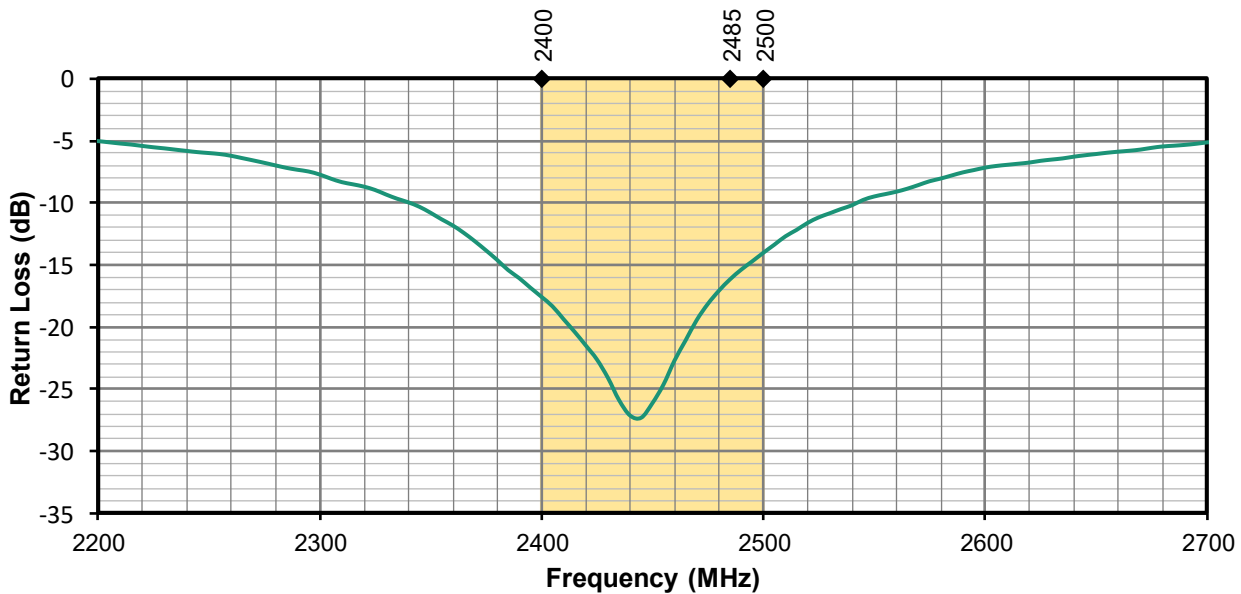

Figure 13. Antenna Return Loss, Edge Bent 90 Degrees

## Peak Gain

The peak gain across the antenna bandwidth is shown in **Figure 14**. Peak gain represents the maximum antenna input power concentration across 3-dimensional space, and therefore peak performance at a given frequency, but does not consider any directionality in the gain pattern.

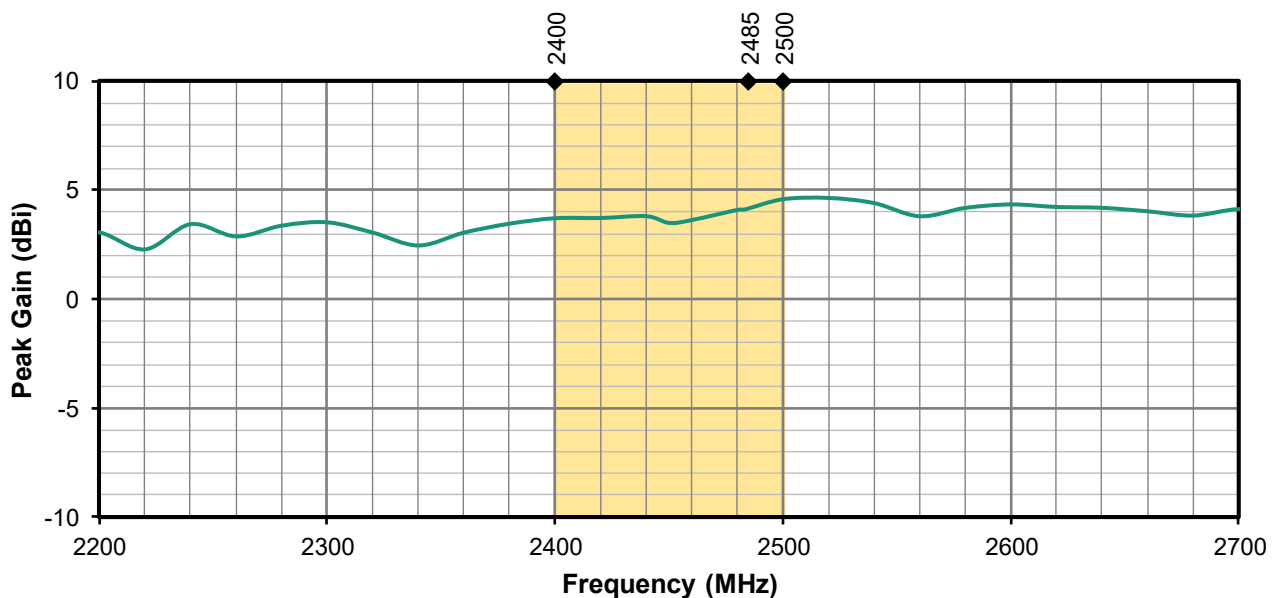

Figure 14. Antenna Peak Gain, Edge Bent 90 Degrees

## Average Gain

Average gain (**Figure 15**), is the average of all antenna gain in 3-dimensional space at each frequency, providing an indication of overall performance without expressing antenna directionality.

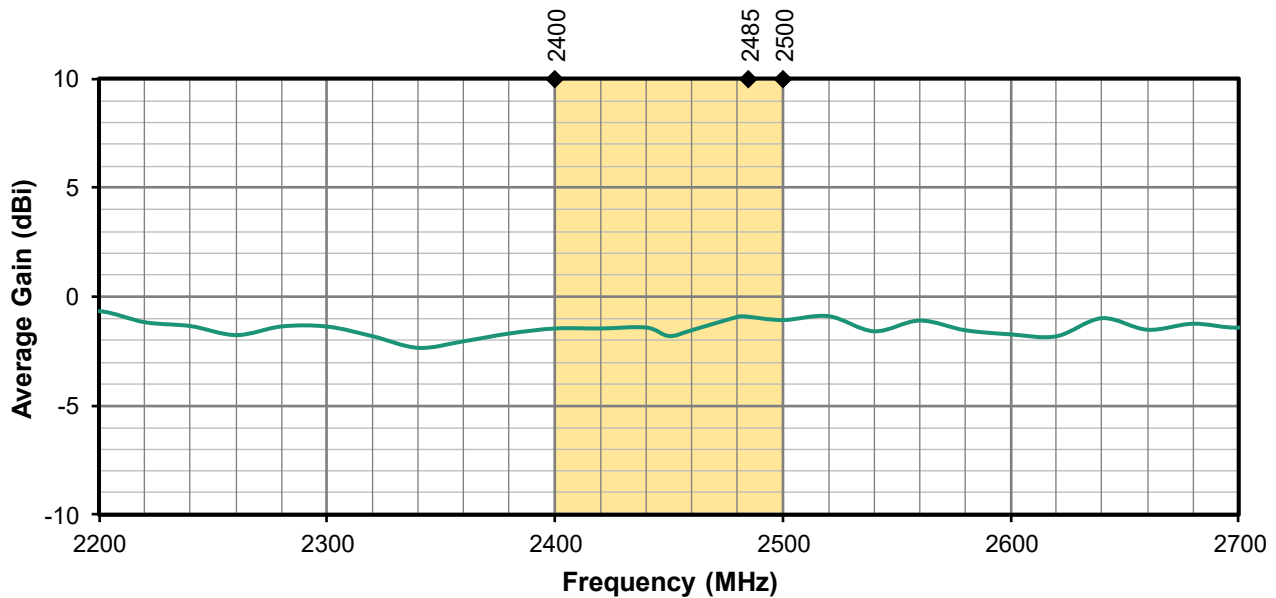

Figure 15. Antenna Average Gain, Edge Bent 90 Degrees

## Radiation Efficiency

Radiation efficiency (**Figure 16**), shows the ratio of power radiated by the antenna relative to the power supplied to the antenna, expressed as a percentage, where a higher percentage indicates better performance at a given frequency. An ideal antenna has 100% efficiency. But in really world, usually an external antenna radiates only 50~60% of power supplied to it.

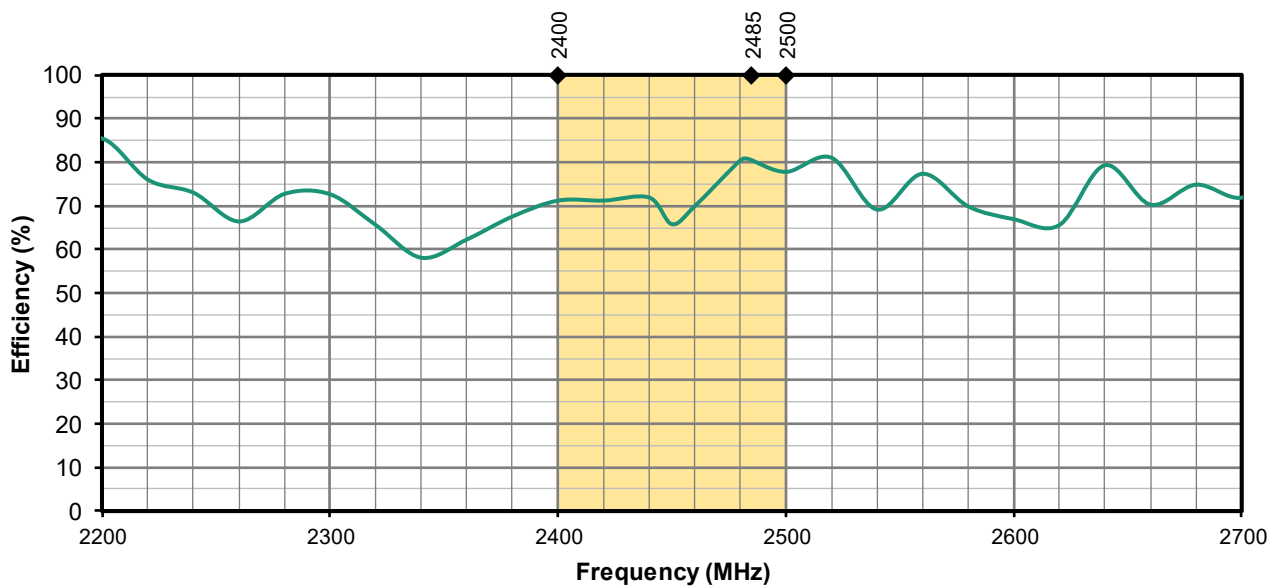
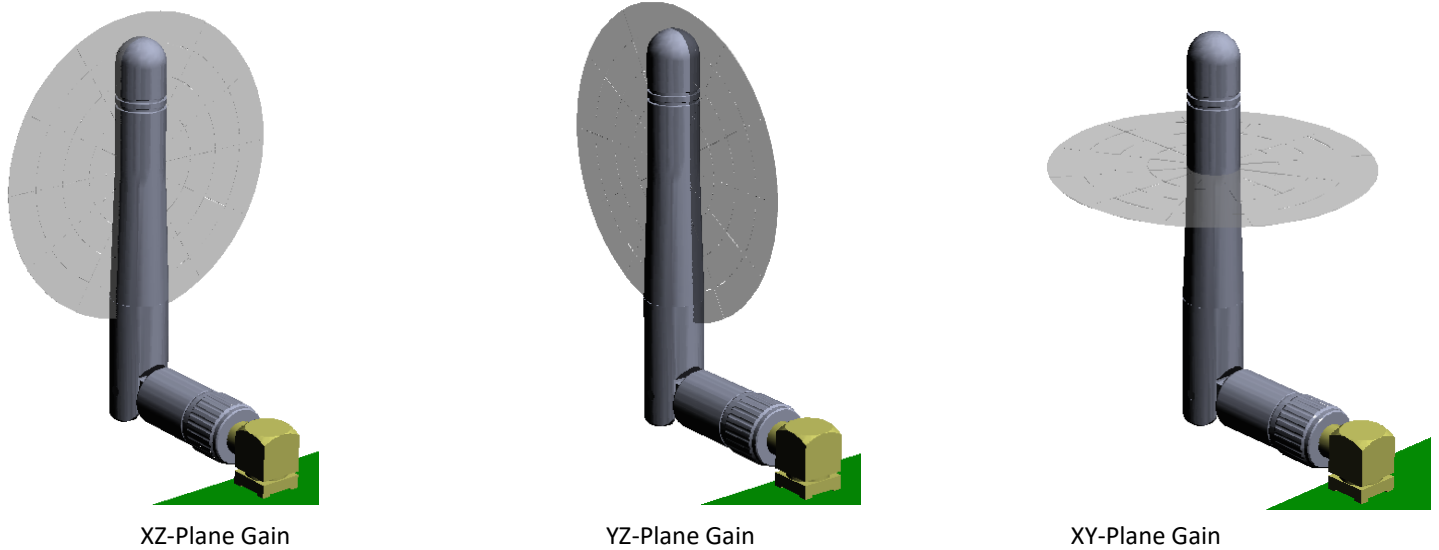

Figure 16. Antenna Efficiency, Edge Bent 90 Degrees

### Radiation Patterns

Radiation patterns provide information about the directionality and 3-dimensional gain performance of the antenna by plotting gain at specific frequencies in three orthogonal planes. Antenna radiation patterns for a 90 bent orientation are shown in **Figure 17** using polar plots covering 360 degrees. The antenna graphic at the top of the page provides reference to the plane of the column of plots below it.



### 2400 MHz to 2500 MHz (2450 MHz)

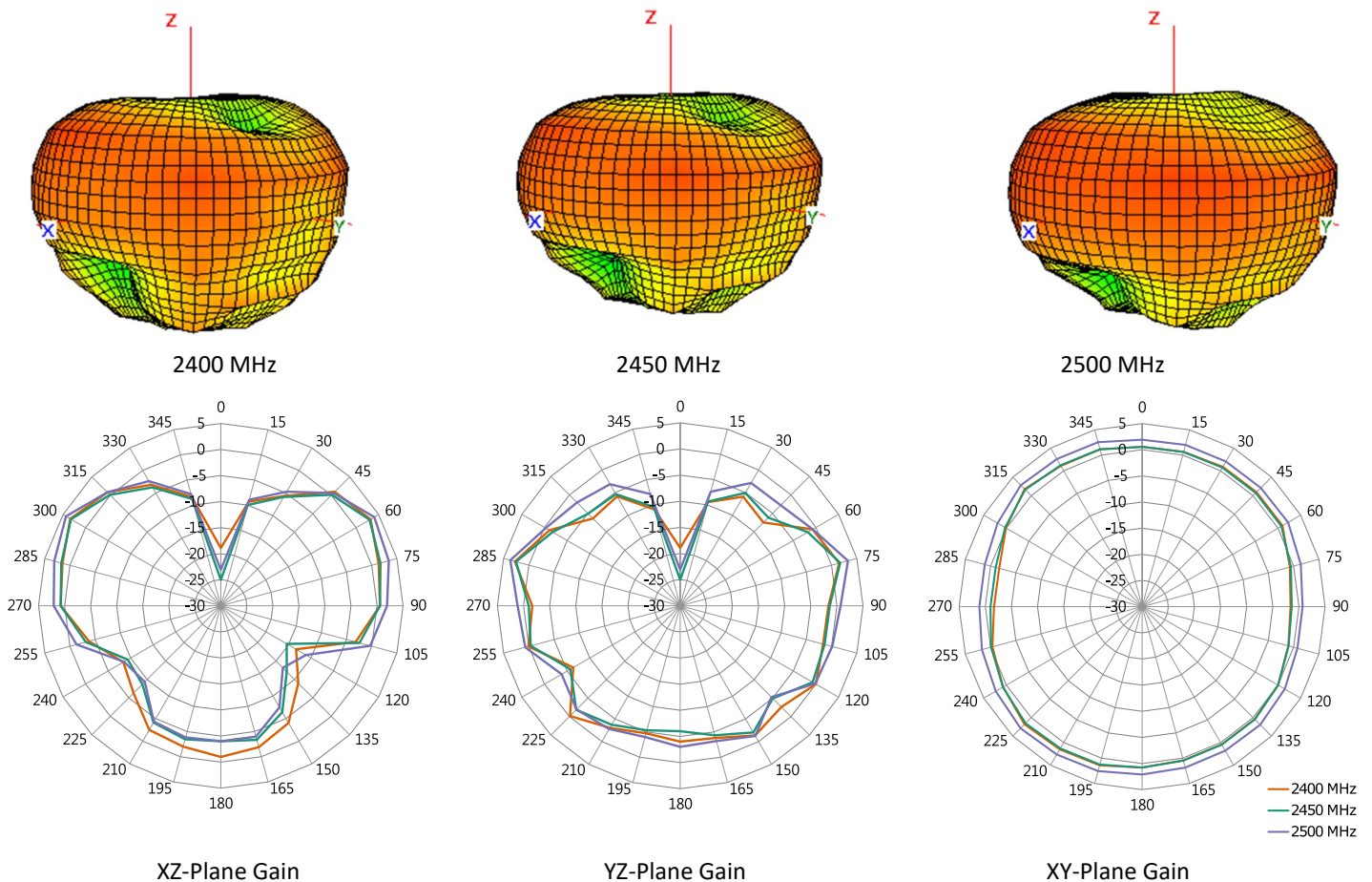

**Figure 17. Antenna Radiation Patterns, Edge Bent 90 Degrees**

## Antenna FAQs

### Q: What is an antenna?

An antenna is used for transmission or reception of radio signals in wireless communication.

### Q: How do antennas work?

Electricity flowing into the transmitter antenna makes electrons vibrate up and down it, producing radio waves. The radio waves travel through the air at the speed of light. When the waves arrive at the receiver antenna, they make electrons vibrate inside it.

### Q: Does antenna size matter?

A bigger antenna, properly designed, will always have more **gain** than a smaller one. And it will be the best kind of **gain**, much better than using a small antenna and simply over-amplifying it, because a small antenna just won't pull in truly weak signals like this gigantic one will.

### Q: What is the advantage of external antennas?

External antennas usually offer **better bandwidth** and **high performance** due to the nature of their larger size. This often results in a higher rated **gain** (dBi) than their internal counterparts. Due to its smaller size, an internal antenna would not function well to support lower frequencies.

Ease of integration – an external antenna requires fewer design resources and shorter time to integrate to allow for a more rapid time-to-market. An internal antenna's performance is influenced by device environment – PCB ground plane, nearby metal part, and enclosure. That would require much more effort such as impedance matching network to complete antenna design

### Q: Why is most antenna impedance 50 Ohm?

50 Ohm is an industry standard of coax cables and power amplifiers. It was chosen as a tradeoff between maximum power handling for the transmit coax and the copper losses. The optimum would have been anyway in the range of **30 to 100 ohm** with average at 50 Ohm

### Q: Why does GNSS require RHCP (Right-hand-circularly-polarized) antennas?

Satellite's signal has a low power density, especially after propagating through the **atmosphere** (**ionosphere** affect radio wave). Polarized waves oscillate in more than one direction, which deliver satellite's signal to receiver on Earth surface more effectively.

---

Website: <https://www.joymax.com.tw>  
Offices: 5, Dong-Yuan 2<sup>nd</sup> Road, Zhong-Li Dist., Tao-Yuan City 32063 Taiwan (R.O.C.)  
Phone: +886 3 433 5698  
E-MAIL: [info@joymax.com.tw](mailto:info@joymax.com.tw)

---

Joymax Electronics reserves the right to make changes to the product(s) or information contained herein without notice. No liability is assumed as a result of their use or application. No rights under any patent accompany the sale of any such product(s) or information.

EnJOY MAX Wireless is a registered trademark of Joymax Electronics Co., Ltd. Other product and brand names may be trademarks or registered trademarks of their respective owners.

Copyright © 2023 Joymax Electronics  
All Rights Reserved.

10/23 RevA